

Informed Search

[RN2] Sec. 4.1, 4.2
[RN3] Sec. 3.5, 3.6

CS 486/686
University of Waterloo
Lecture 3: Sept 18, 2012

Outline

- Using knowledge
 - Heuristics
- Best-first search
 - Greedy best-first search
 - A* search
 - Other variations of A*
- Back to heuristics

Recall from last lecture

- Uninformed search methods expand nodes based on "distance" from start node
 - Never look ahead to the goal
 - E.g. in uniform cost search expand the cheapest path. We never consider the cost of getting to the goal
 - Advantage is that we have this information
- But, we often have some additional knowledge about the problem
 - E.g. in traveling around Romania we know the distances between cities so can measure the overhead of going in the wrong direction

3

cs486/686 Lecture Slides 2012 (c) K. Larson and P. Poupart

Informed Search

- Our knowledge is often on the merit of nodes
 - Value of being at a node
- Different notions of merit
 - If we are concerned about the cost of the solution, we might want a notion of how expensive it is to get from a state to a goal
 - If we are concerned with minimizing computation, we might want a notion of how easy it is to get from a state to a goal
- We will focus on cost of solution

4

cs486/686 Lecture Slides 2012 (c) K. Larson and P. Poupart

Informed search

- We need to develop a domain specific **heuristic function**, $h(n)$
- $h(n)$ **guesses** the cost of reaching the goal from node n
 - The heuristic function must be domain specific
 - We often have some information about the problem that can be used in forming a heuristic function (i.e. heuristics are **domain specific**)

cs486/686 Lecture Slides 2012 (c) K. Larson and P. Poupart

5

Informed search

- If $h(n_1) < h(n_2)$ then we guess that it is cheaper to reach the goal from n_1 than it is from n_2
- We require
 - $h(n) = 0$ when n is a goal node
 - $h(n) \geq 0$ for all other nodes

cs486/686 Lecture Slides 2012 (c) K. Larson and P. Poupart

6

Greedy best-first search

- Use the heuristic function, $h(n)$, to rank the nodes in the fringe
- Search strategy
 - Expand node with lowest h -value
- Greedily trying to find the least-cost solution

7

cs486/686 Lecture Slides 2012 (c) K. Larson and P. Poupart

Greedy best-first search: Example

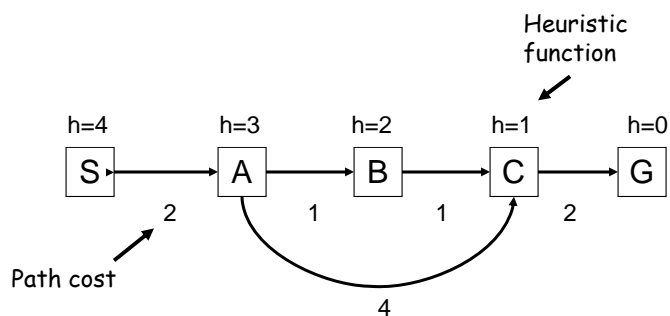

8

cs486/686 Lecture Slides 2012 (c) K. Larson and P. Poupart

Example cont...

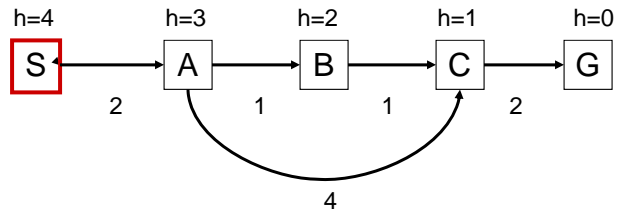

9

cs486/686 Lecture Slides 2012 (c) K. Larson and P. Poupart

Example cont...

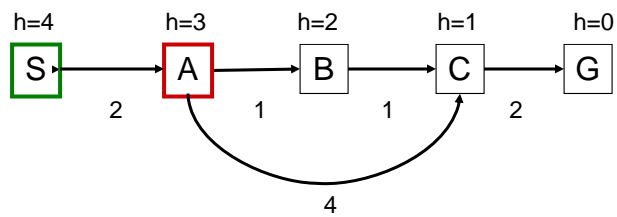

10

cs486/686 Lecture Slides 2012 (c) K. Larson and P. Poupart

Example cont...

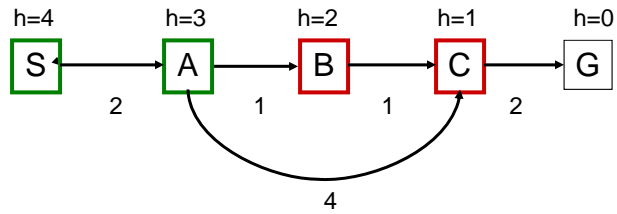

11

cs486/686 Lecture Slides 2012 (c) K. Larson and P. Poupart

Example cont...

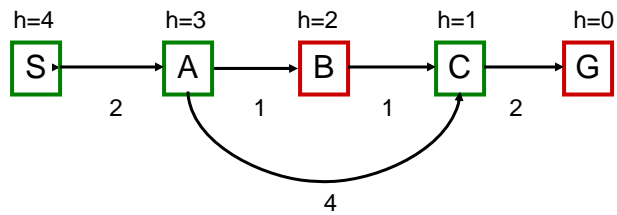

12

cs486/686 Lecture Slides 2012 (c) K. Larson and P. Poupart

Example cont...

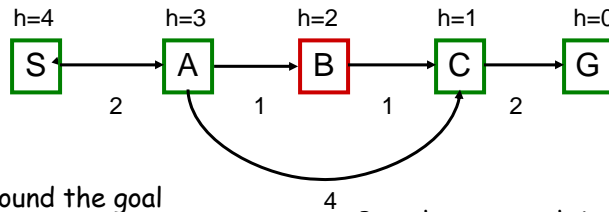

Found the goal

Path is S, A, C, G

Cost of the path is $2+4+2=8$

But cheaper path is S, A, B, C, G

With cost $2+1+1+2=6$

Greedy best-first is not optimal

13

cs486/686 Lecture Slides 2012 (c) K. Larson and P. Poupart

Another Example

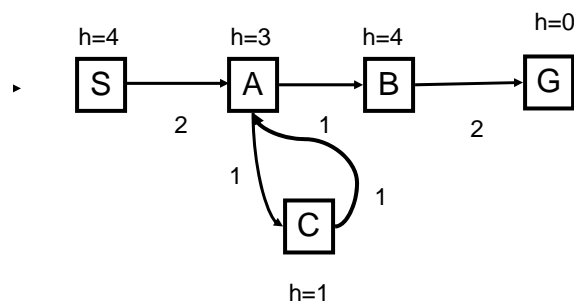

14

cs486/686 Lecture Slides 2012 (c) K. Larson and P. Poupart

Another Example

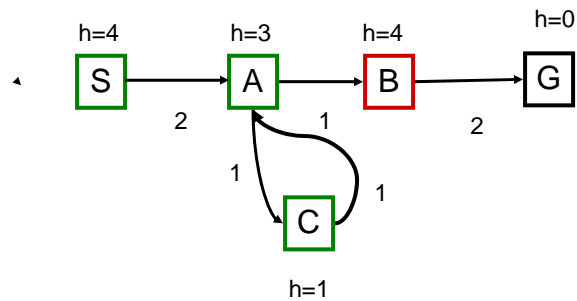

Greedy best-first can get stuck in loops

Not complete

cs486/686 Lecture Slides 2012 (c) K. Larson and P. Poupart

15

Properties of greedy search

- Not optimal!
- Not complete!
 - If we check for repeated states then we are ok
- Exponential space in worst case since need to keep all nodes in memory
- Exponential worst case time $O(b^m)$ where m is the maximum depth of the tree
 - If we choose a good heuristic then we can do much better

cs486/686 Lecture Slides 2012 (c) K. Larson and P. Poupart

16

A* Search

- Greedy best-first search is too greedy
 - It does not take into account the cost of the path so far!
- Define
 - $f(n) = g(n) + h(n)$
 - $g(n)$ is the cost of the path to node n
 - $h(n)$ is the heuristic estimate of the cost of reaching the goal from node n
- A* search
 - Expand node in fringe (queue) with lowest f value

17

cs486/686 Lecture Slides 2012 (c) K. Larson and P. Poupart

A* Example

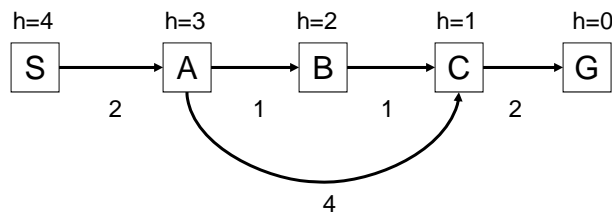

1. Expand S
2. Expand A
3. Choose between B ($f(B) = 3 + 2 = 5$) and C ($f(C) = 6 + 1 = 7$) \Rightarrow expand B
4. Expand C
5. Expand G - recognize it is the goal

18

cs486/686 Lecture Slides 2012 (c) K. Larson and P. Poupart

When should A* terminate?

- As soon as we find a goal state?

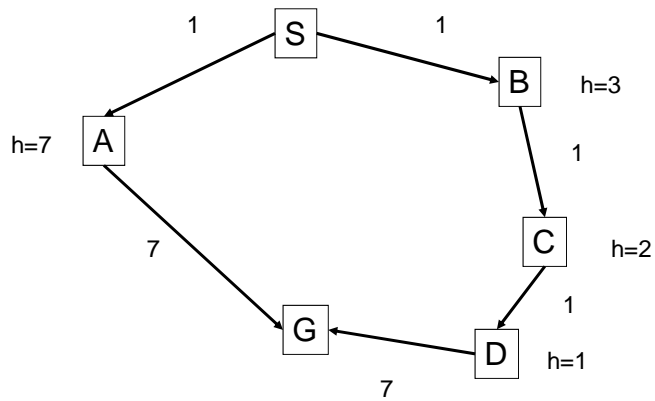

cs486/686 Lecture Slides 2012 (c) K. Larson and P. Poupart

19

When should A* terminate?

- As soon as we find a goal state?

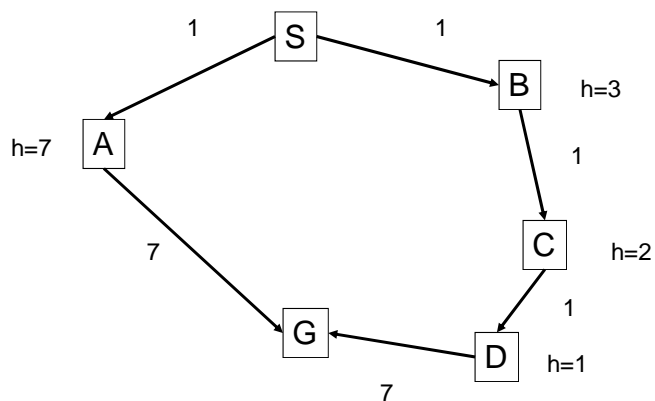

A* Terminates only when goal state is popped from the queue

20

cs486/686 Lecture Slides 2012 (c) K. Larson and P. Poupart

Is A* Optimal?

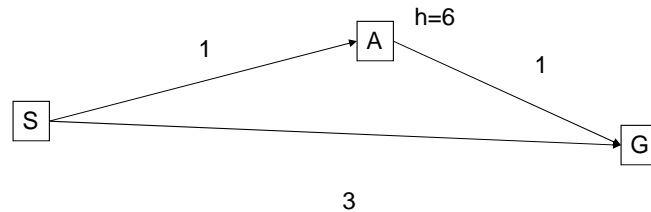

No. This example shows why not.

21

cs486/686 Lecture Slides 2012 (c) K. Larson and P. Poupart

Admissible heuristics

- Let $h^*(n)$ denote the true minimal cost to the goal from node n
- A heuristic, h , is **admissible** if
 - $h(n) \leq h^*(n)$ for all n
- Admissible heuristics never overestimate the cost to the goal
 - Optimistic

22

cs486/686 Lecture Slides 2012 (c) K. Larson and P. Poupart

Optimality of A*

- If the heuristic is admissible then A* with tree-search is **optimal**

Let G be an optimal goal state, and $f(G) = f^* = g(G)$.

Let G_2 be a suboptimal goal state, i.e. $f(G_2) = g(G_2) > f^*$.

Assume for contradiction that A* has selected G_2 from the queue.
(This would terminate A* with a suboptimal solution)

Let n be a node that is currently a leaf node on an optimal path to G .

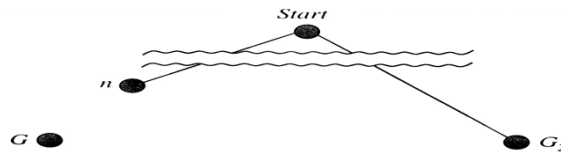

Because h is admissible, $f^* \geq f(n)$.

If n is not chosen for expansion over G_2 , we must have $f(n) \geq f(G_2)$
So, $f^* \geq f(G_2)$. Because $h(G_2)=0$, we have $f^* \geq g(G_2)$, contradiction?

cs486/686 Lecture Slides 2012 (c) K. Larson and P. Poupart

A* and revisiting states

What if we revisit a state that was already expanded?

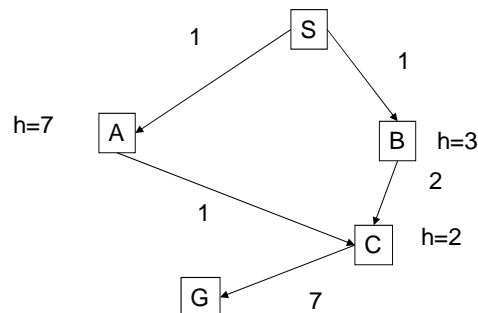

24

cs486/686 Lecture Slides 2012 (c) K. Larson and P. Poupart

A* and revisiting states

What if we revisit a state that was already expanded?

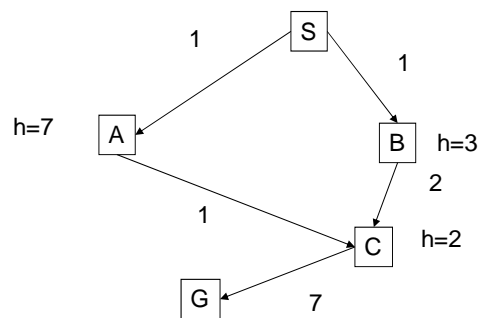

If we allow states to be expanded again, we might get a better solution!

25

cs486/686 Lecture Slides 2012 (c) K. Larson and P. Poupart

Optimality of A*

- For searching graphs we require something stronger than admissibility
 - Consistency (monotonicity):
 - $h(n) \leq \text{cost}(n, n') + h(n') \quad \forall n, n'$
 - Almost any admissible heuristic function will also be consistent
- A* graph-search with a consistent heuristic is optimal

26

cs486/686 Lecture Slides 2012 (c) K. Larson and P. Poupart

Properties of A*

- **Complete** if the heuristic is consistent
 - Along any path, f always increases (if a solution exists somewhere, the f value will eventually get to its cost)
- Exponential time complexity in worst case
 - A good heuristic will help a lot here
 - $O(bm)$ if the heuristic is perfect
- Exponential space complexity

27

cs486/686 Lecture Slides 2012 (c) K. Larson and P. Poupart

Memory-bounded heuristic search

- A* keeps most generated nodes in memory
 - On many problems A* will run out of memory
- Iterative deepening A* (IDA*)
 - Like IDS but change f -cost rather than depth at each iteration
- SMA* (Simplified Memory-Bounded A*)
 - Uses all available memory
 - Proceeds like A* but when it runs out of memory it drops the **worst** leaf node (one with highest f -value)
 - If all leaf nodes have the same f -value then it drops oldest and expands the newest
 - Optimal and complete if depth of shallowest goal node is less than memory size

28

cs486/686 Lecture Slides 2012 (c) K. Larson and P. Poupart

Heuristic Functions

- A good heuristic function can make all the difference!
- How do we get heuristics?
 - One approach is to think of an easier problem and let $h(n)$ be the cost of reaching the goal in the easier problem

29

cs486/686 Lecture Slides 2012 (c) K. Larson and P. Poupart

8-puzzle

7	2	4
5		6
8	3	1

Start State

	1	2
3	4	5
6	7	8

Goal State

- **Relax the game**
 1. Can move tile from position A to position B if A is next to B (ignore whether or not position is blank)
 2. Can move tile from position A to position B if B is blank (ignore adjacency)
 3. Can move tile from position A to position B

30

cs486/686 Lecture Slides 2012 (c) K. Larson and P. Poupart

8-puzzle cont...

- 3 leads to **misplaced tile heuristic**
 - To solve this problem need to move each tile into its final position
 - Number of moves = number of misplaced tiles
 - Admissible
- 1 leads to **manhattan distance heuristic**
 - To solve the puzzle need to slide each tile into its final position
 - Admissible

31

cs486/686 Lecture Slides 2012 (c) K. Larson and P. Poupart

8-puzzle cont...

- h_3 =misplaced tiles
- h_1 =manhattan distance
- Note h_1 **dominates** h_3
 - $h_3(n) \leq h_1(n)$ for all n
 - Which heuristic is best?

32

cs486/686 Lecture Slides 2012 (c) K. Larson and P. Poupart

Designing heuristics

- Relaxing the problem (as just illustrated)
- Precomputing solution costs of subproblems and storing them in a pattern database
- Learning from experience with the problem class

33

cs486/686 Lecture Slides 2012 (c) K. Larson and P. Poupart

Conclusion

- What you should now know
 - Thoroughly understand A^* and IDA^*
 - Be able to trace simple examples of A^* and IDA^* execution
 - Understand admissibility and consistency of heuristics
 - Proof of completeness, optimality
 - Criticize greedy best-first search

34

cs486/686 Lecture Slides 2012 (c) K. Larson and P. Poupart

Next class

- Constraint satisfaction (CSPs)