

CS489/698 Privacy, Cryptography, Network and Data Security

Network Steganography and Information Hiding

Spring 2024, Monday/Wednesday 11:30am-12:50pm

Definitions

Steganography

- Art and science of communicating in a way that hides the existence of a message
 - From the Greek words *steganos* and *graphy*
- Steganography takes one piece of (*secret*) information and hides it within another (*carrier / cover*)



Cryptography vs. Steganography



- **Cryptography:** protects the contents of messages
- **Steganography:** conceals the existence of messages

Steganography system model

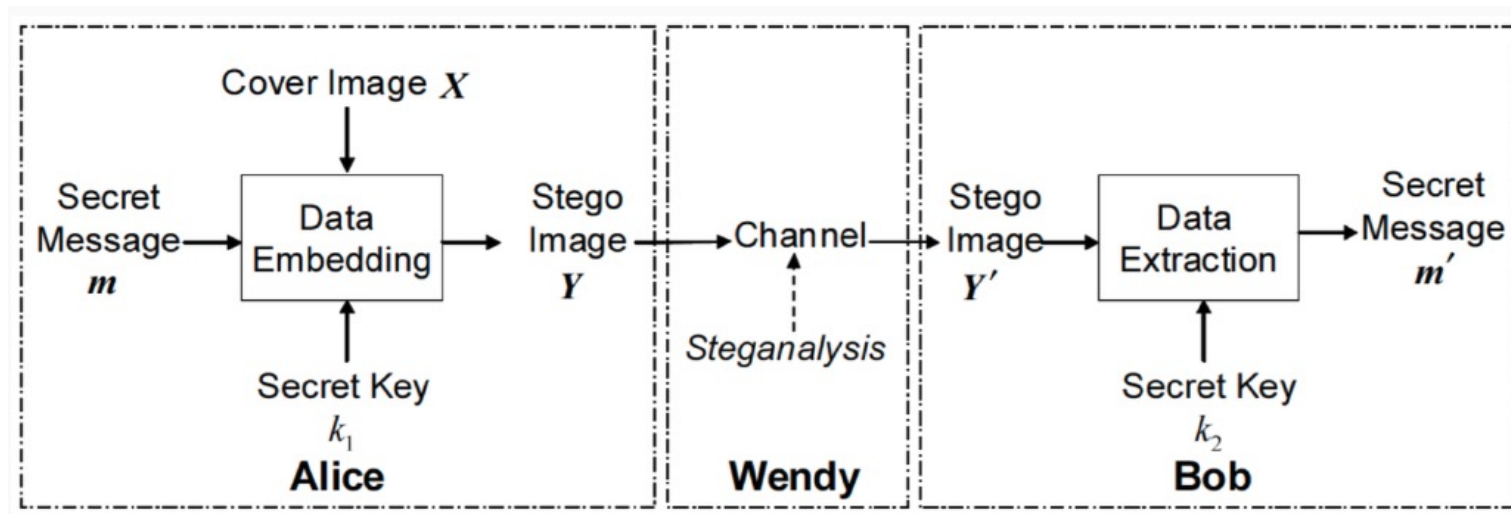

- Wendy can be seen as a warden, and can be:
 - Passive:** attempts to detect whether Y carries secret content
 - Active:** modifies stego image Y into Y' in hopes of destroying the secret content

Why are we studying covert channels?

- Transfer sensitive/unauthorized information through a channel that is not supposed to transmit that information
 - Makes it more difficult to detect data exchanges



Croissant-based covert channel

Why should we care?

- Corporate espionage
- Government or military activities
- Criminal activities
- Censorship circumvention

Covert channel

- A covert channel is a path for the illegal flow of information between subjects within a system, utilizing system resources that were not designed to be used for inter-subject communication.
- What information can be transmitted through a channel may be determined by a policy, physical limitations, etc.

Types of covert channel

- Several dimensions to be considered:
 - Local vs. remote
 - Storage vs. timing
 - Noisy vs. noiseless
- Important characteristics:
 - Bandwidth: how many Bps can be transmitted through the covert channel?
 - Noise: Is the information transmitted through the covert channel distorted in any way?

Local vs. remote covert channels

- Local covert channels leverage a machine's shared resources:
 - CPU, RAM, Disk...
- Remote covert channels leverage transmission mechanisms
 - Typically the network (but also others...)

ETHERLED: Air-gapped systems leak data via network card LEDs

By [Bill Toulas](#)

August 23, 2022 07:28 AM



Covert storage channels

- To use a covert storage channel:
 - Both sender and receiver must have access to some attribute of a shared object.
 - The sender must be able to modify the attribute.
 - The receiver must be able to view that attribute
 - A mechanism must be in place for initiating the sender and receiver processes, and there must be a way to sequence their accesses to the shared resource (e.g., sync header)

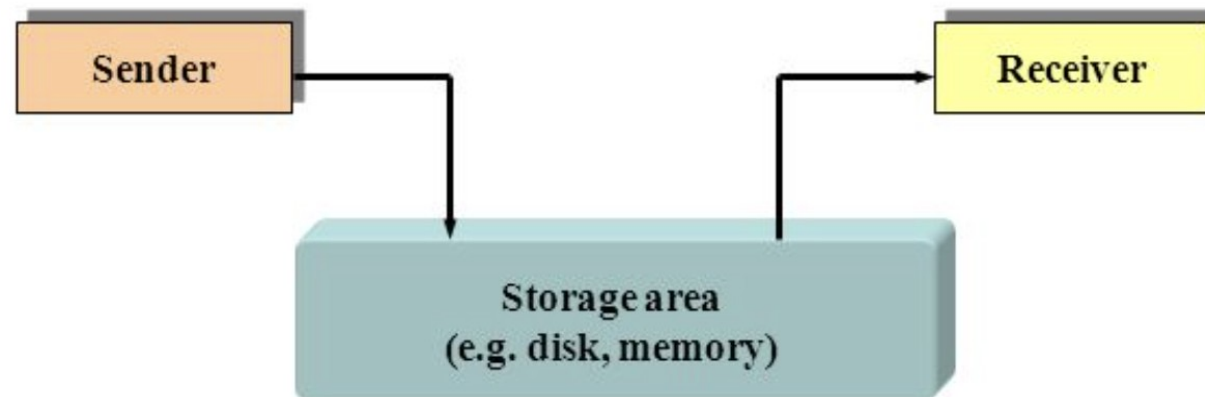

Covert timing channels

- To use a covert timing channel:
 - Both sender and receiver must have access to some attribute of a shared object.
 - Both sender and receiver have access to a time reference (real-time clock, timer, events order).
 - The sender must be able to control the timing of the detection of a change in the attribute of the receiver.

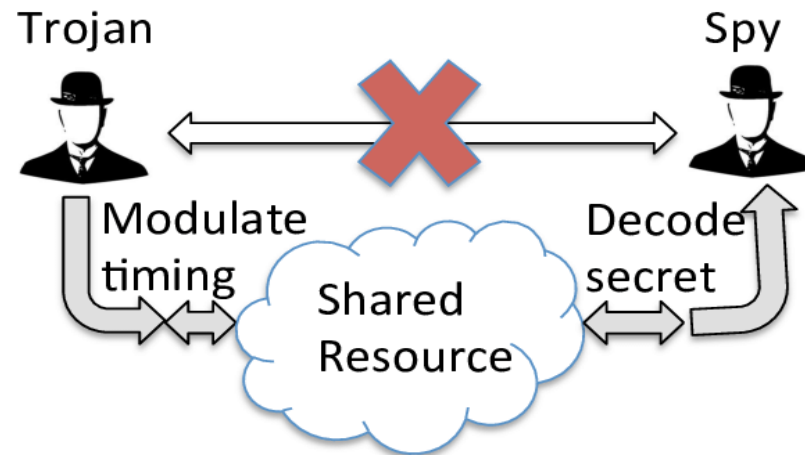

Can't we just get rid of covert channels?

- It is typically infeasible to eliminate every potential covert channel in a (networked) computer system, but we can:
 - Eliminate them by modifying the system implementation.
 - Reduce their bandwidth by introducing noise into the channel.
 - Monitor for usage patterns that indicate someone is trying to exploit a covert channel.

Some attempts at detection

- Kemmerer's Shared Resource Matrix
 - Systematic way to investigate potential covert channels
 - Requires substantial knowledge about the semantics and implementation of system operations.

PRIMITIVE RESOURCE ATTRIBUTE		WRITE	READ	LOCK	UNLOCK	OPEN	CLOSE	FILE	FILE	PROCESS
		FILE	FILE	FILE	FILE	FILE	FILE	LOCKED	OPENED	SLEEP
PROCESS	ID									
	ACCESS RIGHTS	R	R	R	R	R	R	R	R	
	BUFFER	R	R,M							
FILES	ID									
	SECURITY CLASSES	R	R	R	R	R	R	R	R	
	LOCKED BY	R	R	R,M	R	R	R	R	R	
	LOCKED	R	R	R,M	R,M	R	R	R	R	
	IN-USE SET	R	R	R	R	R,M	R,M	R	R	
	VALUE	R,M	R							
CURRENT PROCESS		R	R	R	R	R	R	R	R	R,M
SYSTEM CLOCK		R	R	R	R	R	R	R	R	R

Network Information Hiding

Information hiding in the network

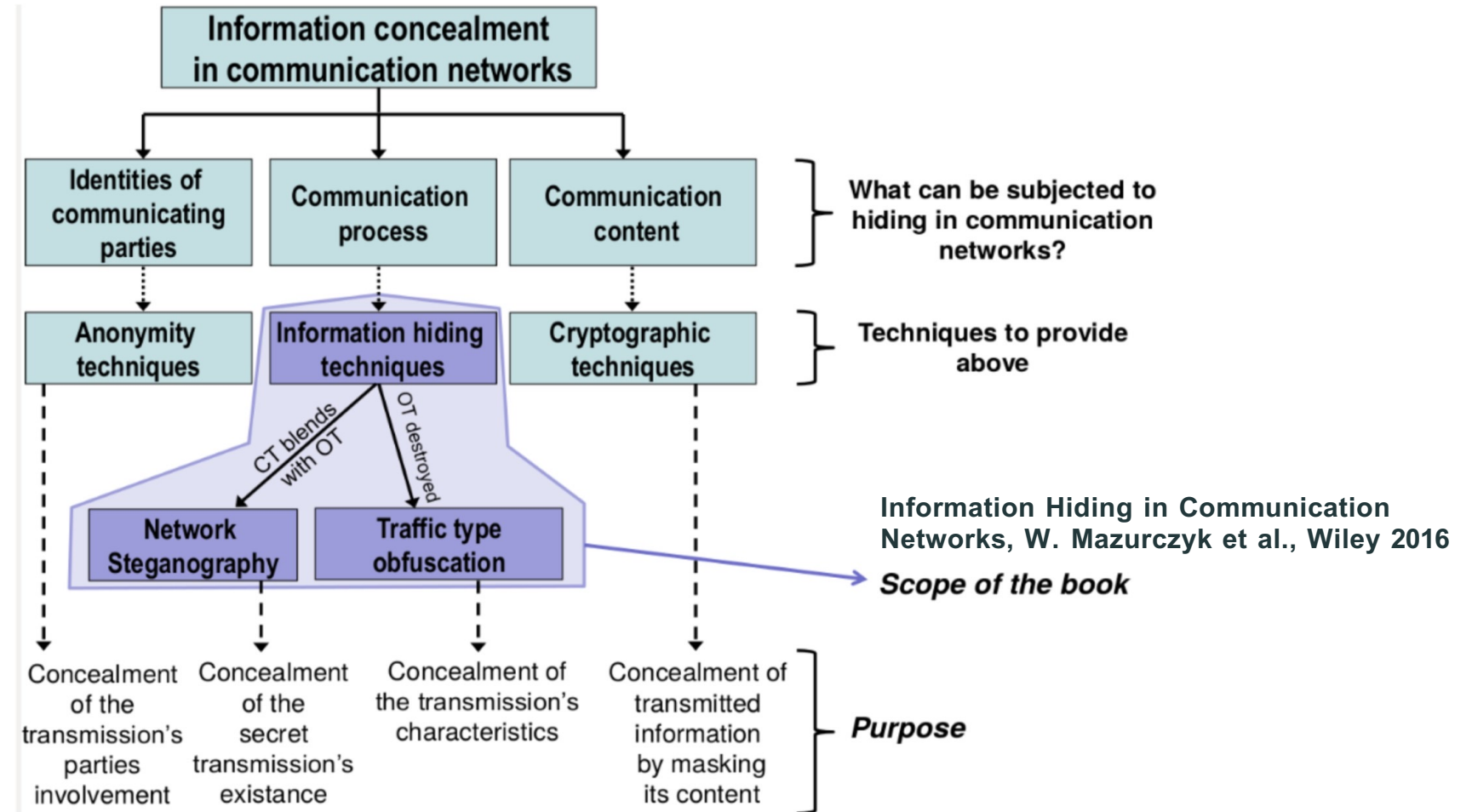

Network Information Hiding

Network covert channels

How do we create a network covert channel?

- **Storage**
 - e.g., packet header manipulations
- **Timing**
 - e.g., timing between packets
- **What about steganography?**
 - We may say that steganographic methods are used to create a network covert channel
- **In a network covert channel:**
 - Covert data is hidden in overt network transmissions
 - The “cover” medium is called a “carrier”

OSI Layers

- We can implement covert channels across the OSI stack

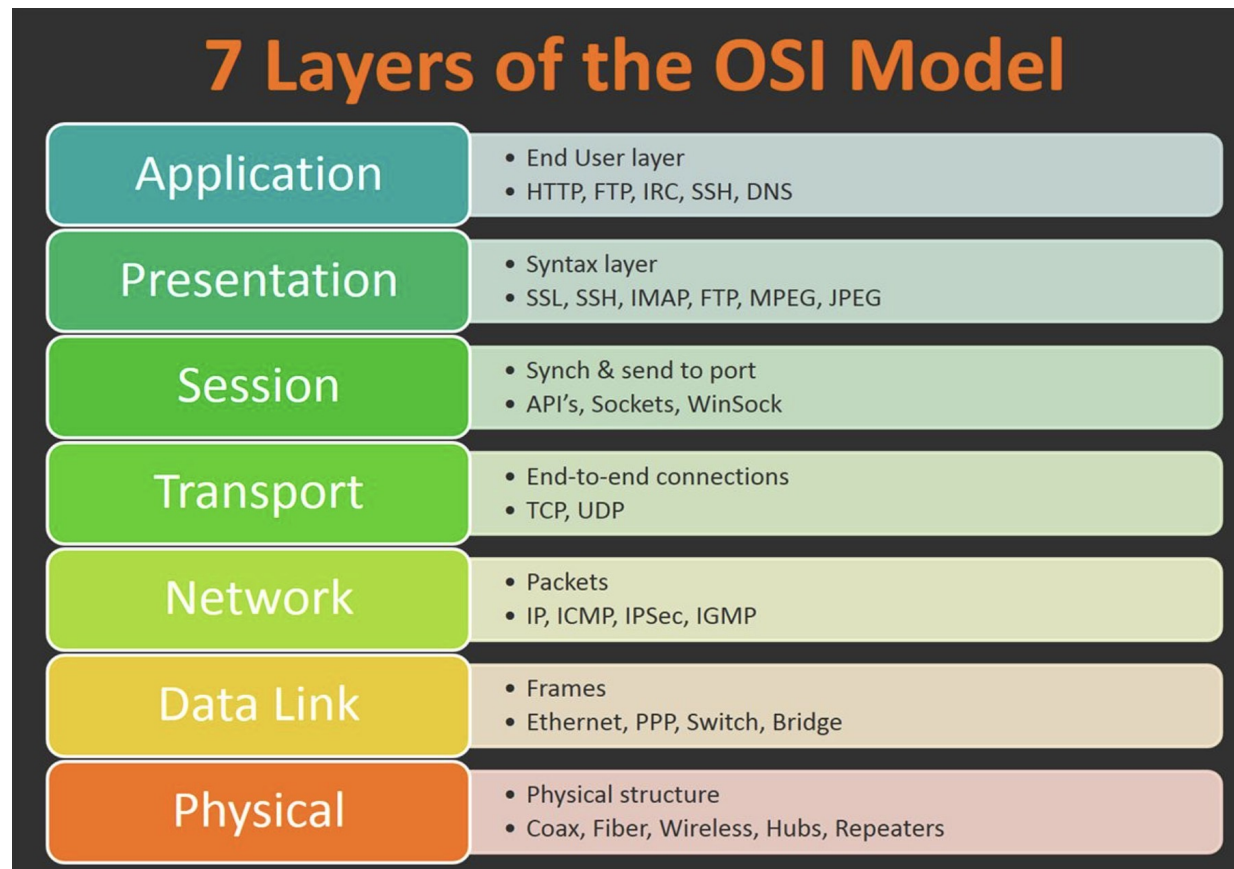

Covert storage channels on TCP/IP

- TCP/IP packets have headers that provide extra information
 - Headers have different fields that are optional or disregarded in usual transmissions
- These fields can be used for hiding information!
 - IP identification
 - Offset
 - Options
 - TCP Checksum
 - TCP Sequence Numbers

IP Header

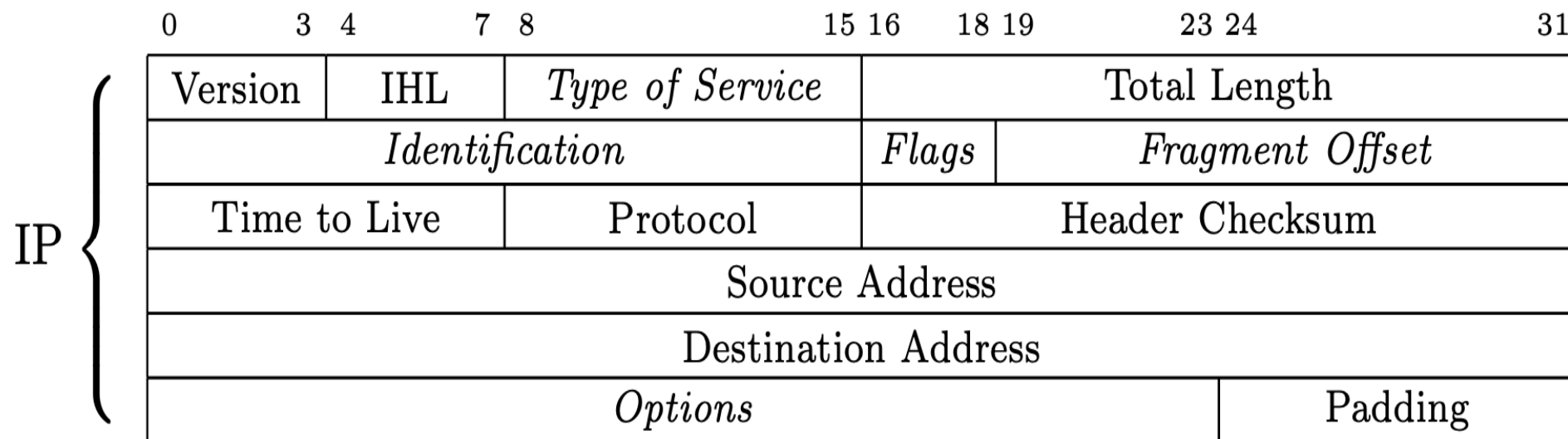

Covert storage channels on IP

- IP ID: a value assigned by the sender to aid in assembling a packet's fragments
- Detection approaches:
 - OpenBSD toggles the most significant bit of the IP ID every 3 minutes or 30,000 IP IDs, so the MSB can be examined to check if it matches this pattern.
 - Within a rekey interval, the OpenBSD IP ID is nonrepeating

Embedding Covert Channels into TCP/IP, Murdoch and Lewis, International Workshop on Information Hiding, 2005

TCP Header

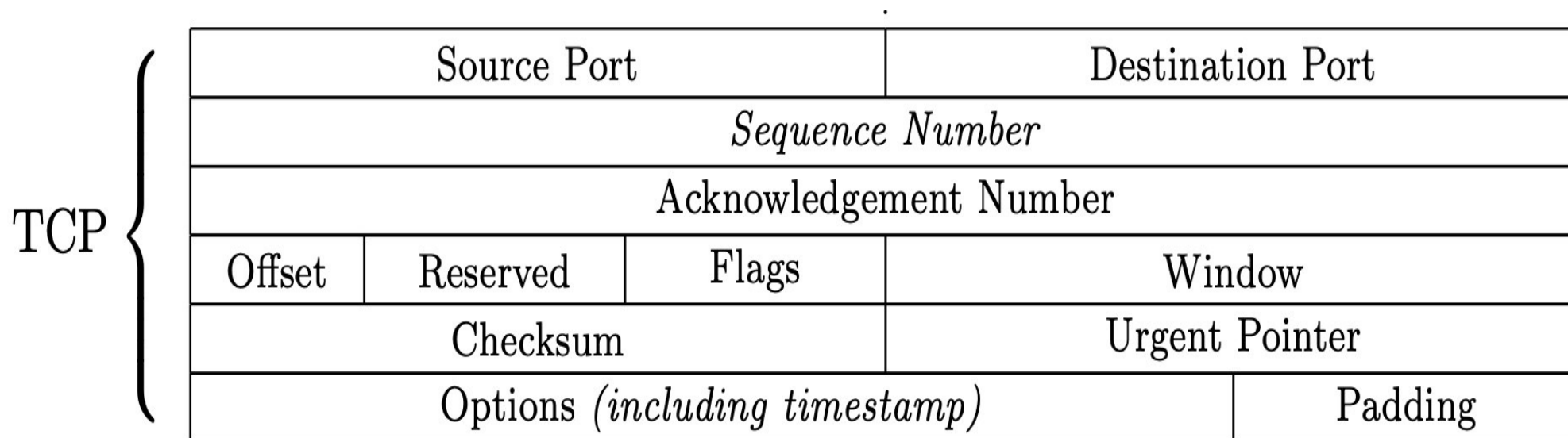

Covert storage channels on TCP/IP

- TCP ISN: initial sequence number on TCP connections

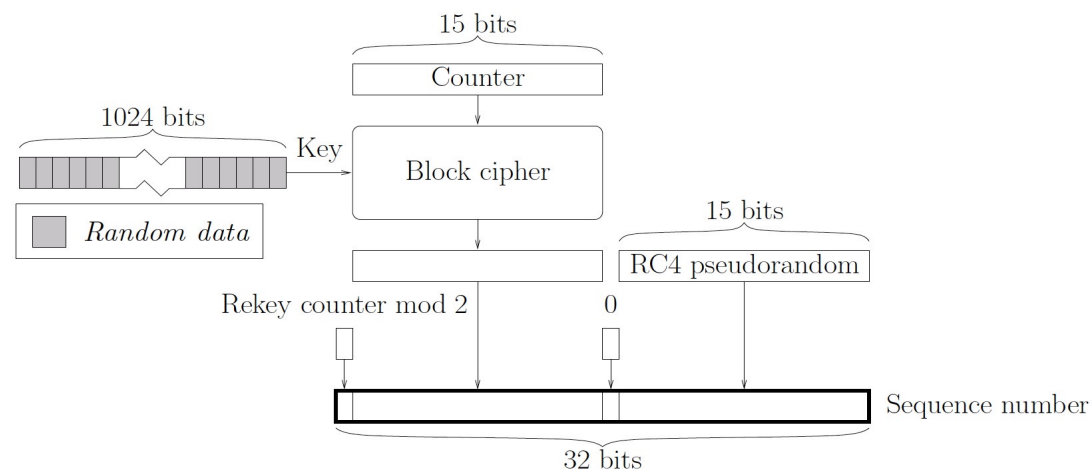
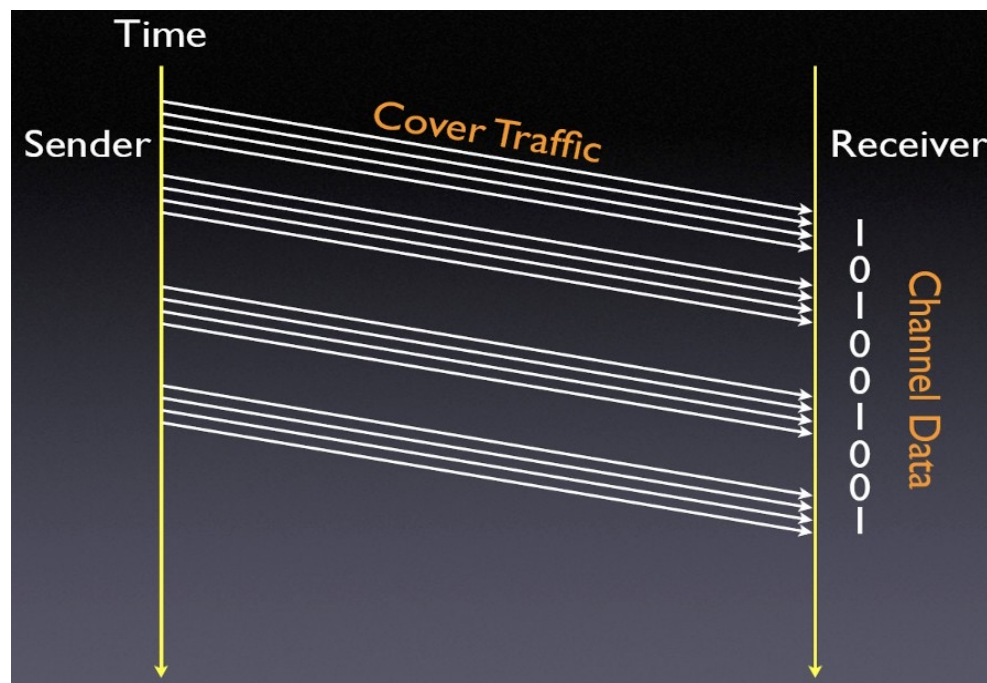

Fig. 4. OpenBSD ISN generator

- Several constraints make steganography easily detectable
- Embedding Covert Channels into TCP/IP, Murdoch and Lewis, IWIH, 2005

Covert timing channels on TCP/IP

- These typically propagate covert information by crafting delays between certain events
 - e.g., modify usual inter-packet delay, introduce losses by skipping sequence numbers



Covert storage & timing channels on TCP/IP

- We may also have hybrids of storage and timing (e.g., LACK)
 - Replace encrypted packet contents with covert data and use delays for signalling the receiver about specific packets

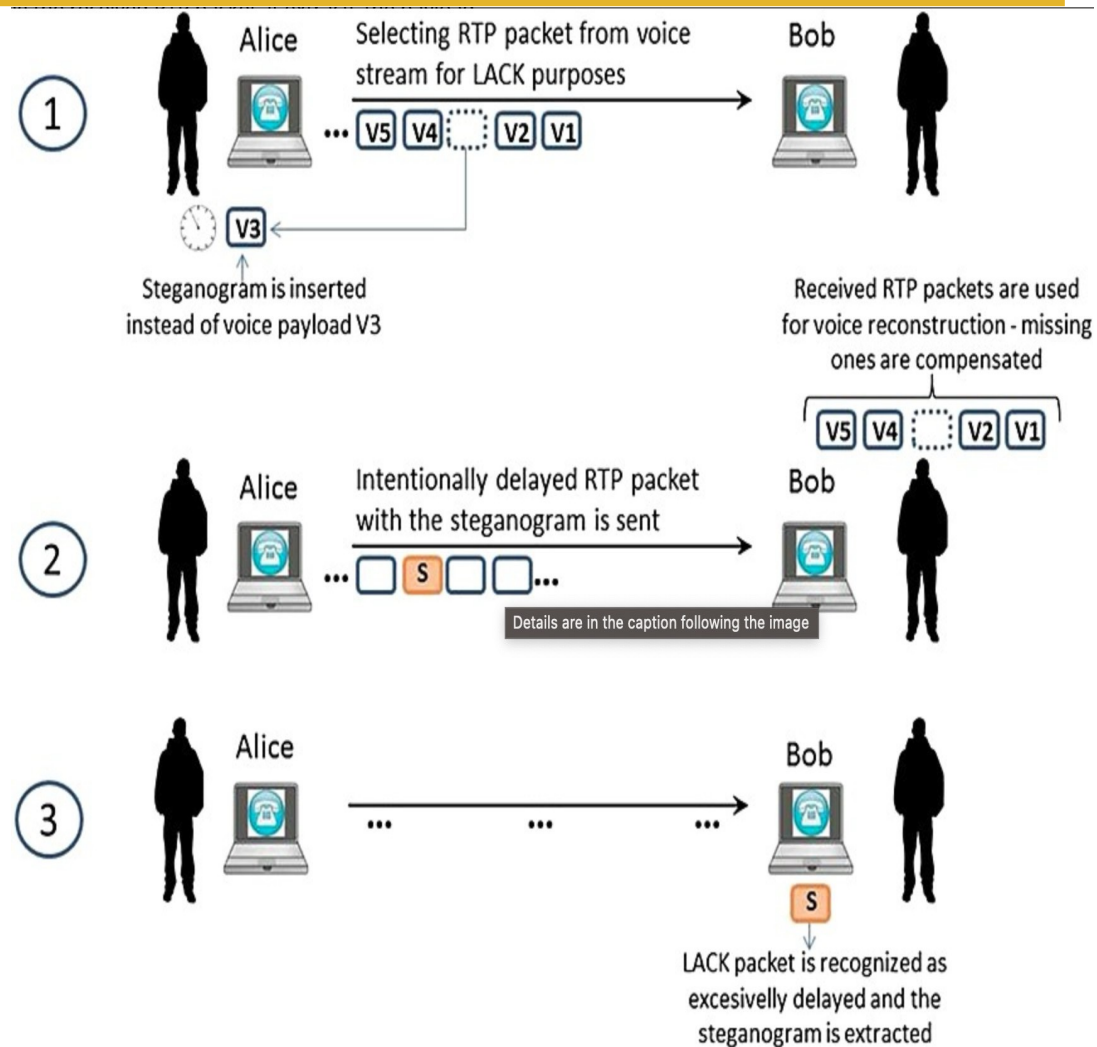

Covert channels at the application level

- Many examples:
 - HTTP
 - DNS
 - Games
 - VoIP/video traffic
 - Push notifications
 - ...

Example: DNS Tunneling

- DNS Tunneling is based on encoding the data of other programs or protocols in DNS queries and responses

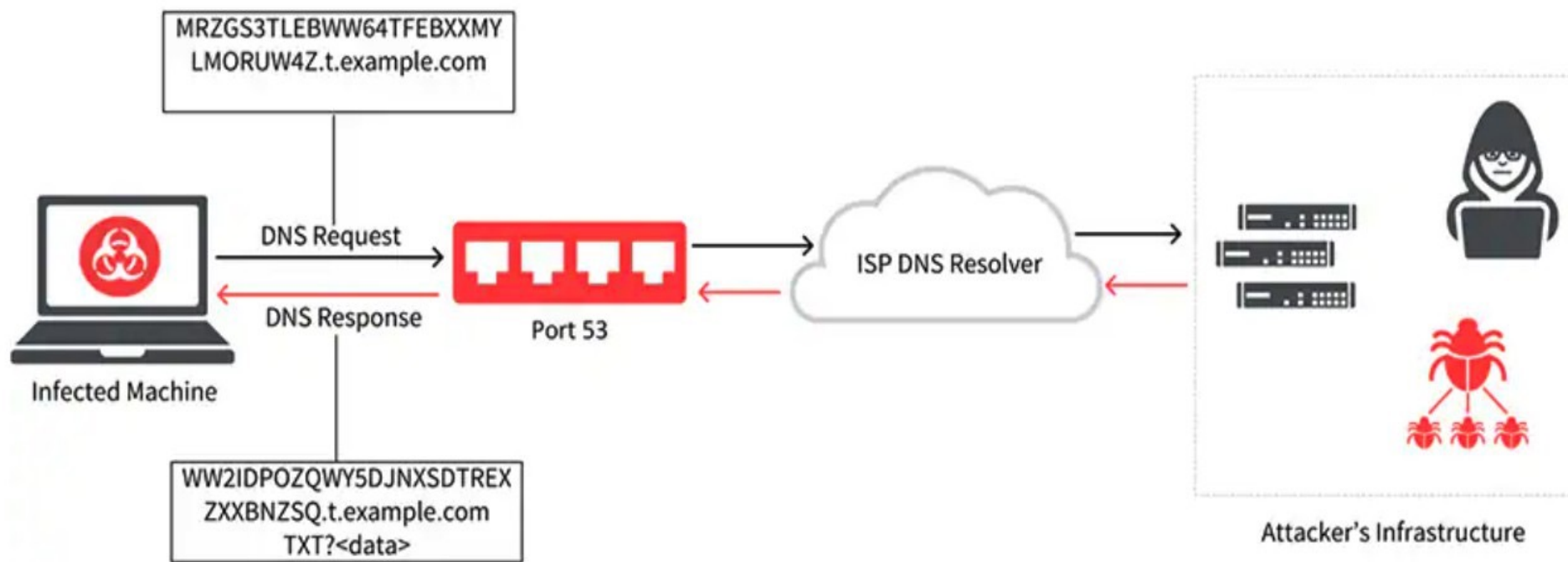

Example: Games

- We can create covert channels by encoding information in games' virtual worlds which are shared by multiple users

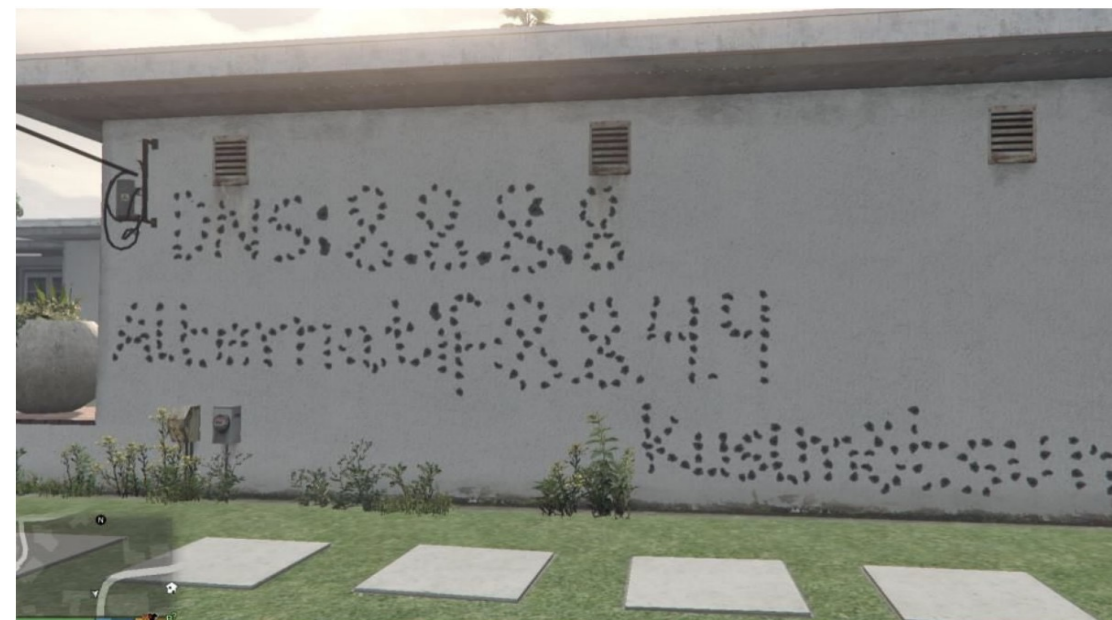

How to detect/prevent network covert channels

- A warden inspects (and/or manipulates) traffic to detect (and/or break) covert channels
- Storage channels
 - Passive: Analyze transmitted data for anomalies.
 - Active: Normalize data in header fields
- Timing channels
 - Passive: Analyze packet timing for inconsistencies
 - Active: Shape traffic (e.g., constant rate)

File Formats (and a little help for A2)

A Primer on File Formats

- A file format is a standard way that information is encoded for storage in a computer file
- There are two broad file format families:
 - Text files: Essential to determine the text encoding scheme and structure (if any)
 - Binary files: Essential to determine the file format

vector	AI	EPS	CDR	SVG	WMF	ART	CGM	EMF	VSD	PS
image	TIF	PSD	JPG	GIF	PNG	BMP	TGA	ICO	HDR	RAW
text	PDF	TXT	DOC	RTF	ODT	SUB	UNX	ORT	CHM	WPD
audio	MP3	WAV	AAC	FLAC	CDA	MIDI	RMF	OGG	VOC	WMA
video	QT	FLV	MP4	AVI	3GP	MPG	MKV	MOV	ASF	VOB
ebook	FB2	DJVU	MOBI	EPUB	IW4	PRC	CHM	TCR	EBK	AZW
archive	ZIP	RAR	ISO	JAR	TAR	ACE	LZH	ARJ	CAB	ZOO
internet	JS	HTM	CSS	XML	MHT	PSP	EML	PHP	JAVA	PY
other	INI	SYS	KEY	PPT	NFO	XLS	CSV	CAB	MDB	COM
bonus	SWF	EXE	DAT	HLP	DLL	FAQ	RSS	FON	TTF	OTF

Text Files

- Text files can have some structure on their own
 - E.g., XML, HTML, JSON, etc.

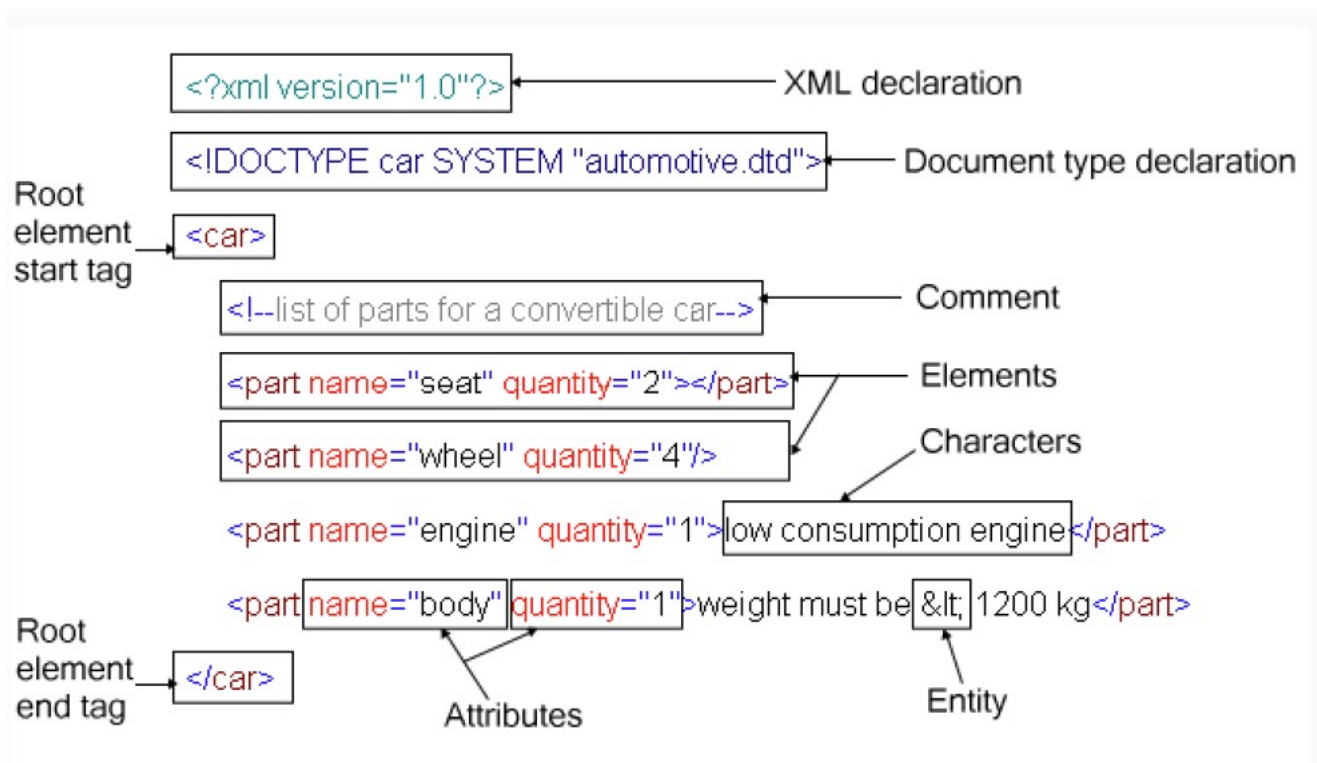

Text Files

- Text files can have some structure on their own
 - E.g., XML, HTML, JSON, etc.

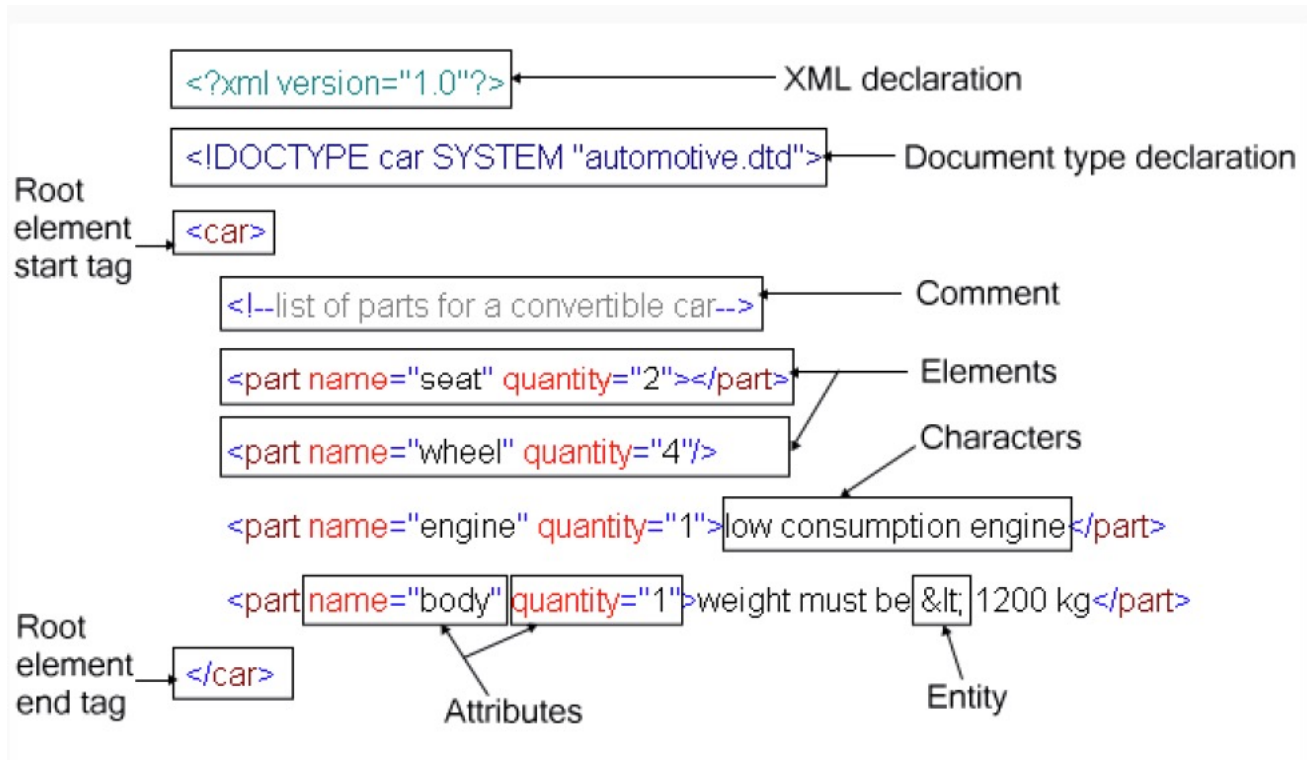

Some of these elements may be used to store covert data as part of a covert storage channel...



Binary Files

- In binary files, bytes represent custom data
- Binary file formats may include multiple types of data in the same file, such as image, video, and audio data
 - This data can be interpreted by supporting programs, but will show up as garbled text in a text editor



Inspection of a file's raw bytes

- Use an hex editor to read file contents, e.g., xxd

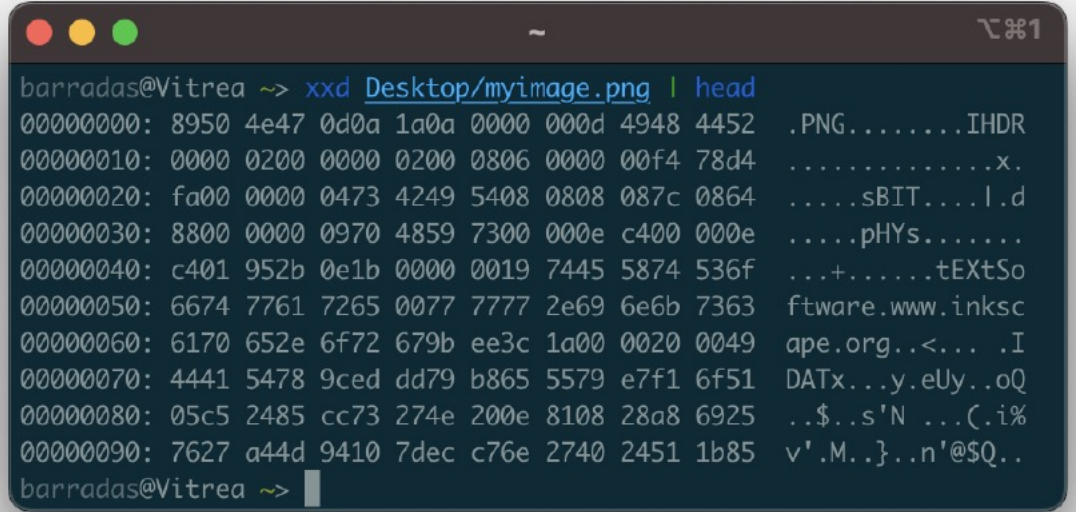

```
barradas@Vitrea ~-> xxd Desktop/myimage.png | head
00000000: 8950 4e47 0d0a 1a0a 0000 000d 4948 4452  .PNG.....IHDR
00000010: 0000 0200 0000 0200 0806 0000 00f4 78d4  .....x.
00000020: fa00 0000 0473 4249 5408 0808 087c 0864  ....sBIT...l.d
00000030: 8800 0000 0970 4859 7300 000e c400 000e  ....pHYs.....
00000040: c401 952b 0e1b 0000 0019 7445 5874 536f  ...+.....tEXtSo
00000050: 6674 7761 7265 0077 7777 2e69 6e6b 7363  ftware.www.inksc
00000060: 6170 652e 6f72 679b ee3c 1a00 0020 0049  ape.org.<... .I
00000070: 4441 5478 9ced dd79 b865 5579 e7f1 6f51  DATx...y.eUy..oQ
00000080: 05c5 2485 cc73 274e 200e 8108 28a8 6925  ..$.s'N ...(.i%
00000090: 7627 a44d 9410 7dec c76e 2740 2451 1b85  v'.M.}.n'@$Q..
barradas@Vitrea ~->
```

- Use the file utility to match a file's signature

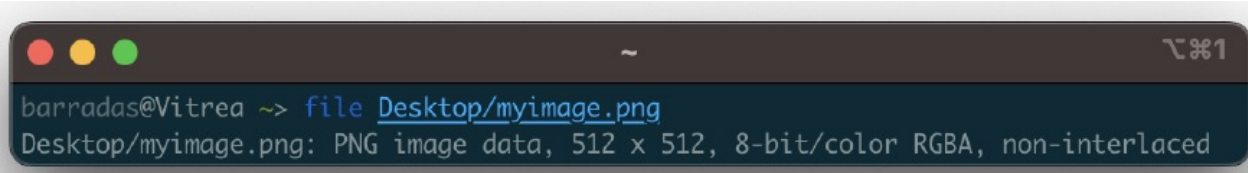

```
barradas@Vitrea ~-> file Desktop/myimage.png
Desktop/myimage.png: PNG image data, 512 x 512, 8-bit/color RGBA, non-interlaced
```

Magic Numbers

- When in doubt, look for magic numbers
 - Numerical/text values used to identify a file or protocol
 - E.g., GIF files start with the sequence 0x47 49 46 38 39 61

Actual Size (10x10) Enlarged (100x100)

Bytes

47	49	46	38	39	61	0A	00	0A	00	91	00	00	FF	FF	FF	FF	00
00	00	00	FF	00	00	00	21	F9	04	00	00	00	00	00	2C	00	00
00	00	0A	00	0A	00	00	02	16	8C	2D	99	87	2A	1C	DC	33	A0
02	75	EC	95	FA	A8	DE	60	8C	04	91	4C	01	00	3B			

- Magic numbers of common file formats:
- http://www.garykessler.net/library/file_sigs.html

Magic Numbers

- When in doubt, look for magic numbers
 - Numerical/text values used to identify a file or protocol
 - E.g., GIF files start with the sequence 0x47 49 46 38 39 61

Actual Size Enlarged Bytes GIF's magic number

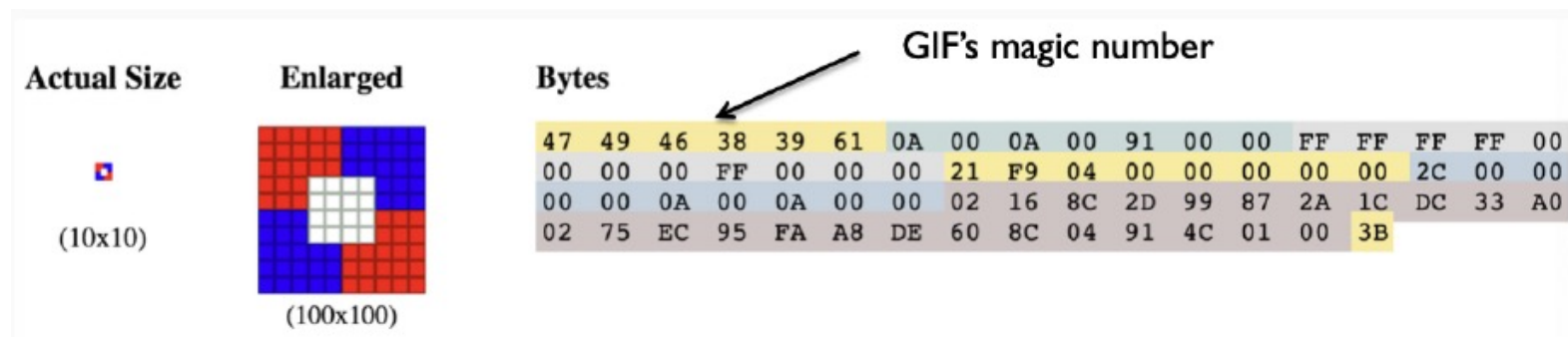

47	49	46	38	39	61	0A	00	0A	00	91	00	00	FF	FF	FF	FF	00
00	00	00	FF	00	00	00	21	F9	04	00	00	00	00	00	2C	00	00
00	00	0A	00	0A	00	00	02	16	8C	2D	99	87	2A	1C	DC	33	A0
02	75	EC	95	FA	A8	DE	60	8C	04	91	4C	01	00	3B			

- Magic numbers of common file formats:
- http://www.garykessler.net/library/file_sigs.html

Maybe I can use this to make sense out of what's being transmitted within a covert storage channel...



Network Information Hiding

Traffic obfuscation

Information concealment in networks

- Timing and content anomalies may be an effective way to detect covert channels
- Are there better ways to hide the existence of covert data transmissions?

Information concealment in networks

- Well, yes!
- Traffic obfuscation:
 - Hide the characteristics of a covert data transmission by shaping the “look” of data exchanges
 - e.g., used to hide malware communication with a C&C server, evade censorship, etc.

Different techniques for traffic obfuscation

- Randomize traffic
 - Don't look like any particular protocol
- Mimic traffic
 - Attempt to look like some other protocol
- Tunnel traffic
 - Piggyback on another protocol's execution

Traffic randomization

- Idea: evade inspection by generating traffic that does not conform to any known protocol specification
 - Randomize packet sizes and timings
 - Randomize packet contents (no signatures)
- Examples:
 - Shadowsocks
 - V2Ray
 - OutlineVPN

Issues with traffic randomization systems

- “Look-like-nothing” might be a signature in itself
- Does not work if wardens have protocol allowlists in place
- Can be detected via cryptographic flaws and entropy tests
 - Security Notions for Fully Encrypted Protocols, Fenske and Johnson, FOCI 2023
 - How the Great Firewall of China Detects and Blocks Fully Encrypted Traffic, Wu et al., USENIX Security 2023

Traffic mimicking

- Idea: Hide a protocol's execution by mimicking another innocuous protocol's characteristics (e.g., Skype)
 - Leverage steganography or encrypted carrier protocols
 - Embed covert data in specific protocol fields
 - Mimic how an encrypted cover protocol sends its traffic
- Examples:
 - SkypeMorph
 - StegoTorus
 - CensorSpoofer

Issues with traffic mimicking systems

- It is very difficult to build a perfect imitation
 - Respond to network perturbations
 - Cover all corner cases and error conditions (and bugs!)
 - Mimic relationships between sub-protocols
 - Keep up with the cover protocol's updates
- Now believed to be a fundamentally flawed approach
 - The Parrot is Dead: Observing Unobservable Network Communications, Houmansadr et al., S&P 2013

Traffic tunneling

- **Idea: Piggyback covert data on the execution of a protocol**
 - Send covert data as the protocol's application messages
 - Avoids mimicking issues
 - Still needs to ensure the cover protocol does not generate “weird” traffic patterns

- **Examples:**
 - VoIP/video: FreeWave, DeltaShaper, Protozoa
 - HTTPS: meek, decoy routing, Balboa
 - IM/e-mail: Camoufler, SWEET
 - Cellphones: Dolphin

Issues with traffic tunneling systems

- Oftentimes, there is a disconnect between the usage patterns of the cover protocol and the covert protocol
 - Times of use, duration, etc.
 - The “greedy” tunneling of covert data may change the cover protocol’s typical traffic patterns
 - e.g., exchanging very large IMs very frequently on both directions
 - Covert data embedding mechanisms may slow down the cover’s protocol activity, leading to noticeable changes in traffic patterns
 - e.g., when replacing media data with covert content

Takeaways

- Covert channels allow for the surreptitious transfer of information, both within processes of a given machine or across machines
- Network covert channels are increasingly hard to detect, but can also be used for commendable purposes (e.g., censorship evasion within repressive environments)