



# Nimber Sequences of Node-Kayles Games

Sierra Brown  
Department of Mathematics  
Creighton University  
2500 California Plaza  
Omaha, NE 68178  
USA

[sierrabrown@creighton.edu](mailto:sierrabrown@creighton.edu)

Spencer Daugherty  
Department of Mathematics and Statistics  
Mount Holyoke College  
50 College Street  
South Hadley, MA 01075  
USA

[daugh22s@mtholyoke.edu](mailto:daugh22s@mtholyoke.edu)

Eugene Fiorini  
Department of Mathematics  
Muhlenberg College  
2400 Chew Street  
Allentown, PA 18104  
USA

[eugenefiorini@muhlenberg.edu](mailto:eugenefiorini@muhlenberg.edu)

Barbara Maldonado  
Department of Mathematics  
University of Houston  
3507 Cullen Boulevard  
Houston, TX 77204  
USA

[barbara.maldonado23230@gmail.com](mailto:barbara.maldonado23230@gmail.com)

Diego Manzano-Ruiz  
Department of Mathematics  
Kutztown University of Pennsylvania  
15200 Kutztown Road  
Kutztown, PA 19530  
USA

[dmanz394@live.kutztown.edu](mailto:dmanz394@live.kutztown.edu)

Sean Rainville  
Department of Mathematics  
Plymouth State University  
17 High Street  
Plymouth, NH 03264  
USA

[ser1008@plymouth.edu](mailto:ser1008@plymouth.edu)

Riley Waechter  
Department of Mathematics and Statistics  
Northern Arizona University  
801 South Osborne Drive  
Flagstaff, AZ 86011  
USA

[rsw66@nau.edu](mailto:rsw66@nau.edu)

Tony W. H. Wong  
Department of Mathematics  
Kutztown University of Pennsylvania  
15200 Kutztown Road  
Kutztown, PA 19530  
USA

[wong@kutztown.edu](mailto:wong@kutztown.edu)

## Abstract

Node-Kayles is an impartial game played on a simple graph. The Sprague-Grundy theorem states that every impartial game is associated with a nonnegative integer value called a Nimber. This paper studies the Nimber sequences of various families of graphs, including 3-paths, lattice graphs, prism graphs, chained cliques, linked cliques, linked cycles, linked diamonds, hypercubes, and generalized Petersen graphs. For most of these families, we determine an explicit formula or a recursion on their Nimber sequences.

## 1 Introduction

An *impartial game* is a combinatorial two-player game with complete information, in which the allowable moves from any position are identical for both players. One of the classical examples is the game of Nim. The Sprague-Grundy theorem [1] states that all impartial games can be analyzed by assigning a nonnegative integer value, often called the *Grundy number* or the *Nimber*, to each game position recursively. According to this theorem, the Nimber of a game is 0 if and only if the game is second-player winning, i.e., the second player has a winning strategy regardless of the moves of the first player. Readers may refer to *Winning Ways for Your Mathematical Plays: Volume 1* [2] for more information on impartial games.

*Node-Kayles*, also known as the *domination game* [3], is an impartial game played on a simple graph  $G$ . Players move alternately. A move involves removing a vertex  $v$ , its neighbors  $N_G(v)$ , and all edges incident to all vertices in  $\{v\} \cup N_G(v)$  from  $G$ . The first player unable to make a legal move loses the game. In the rest of this article, we let  $N_G[v]$  denote  $\{v\} \cup N_G(v)$ , the *closed neighborhood* of  $v$ . Furthermore, we let  $G_v$  denote the residue subgraph  $G - N_G[v]$ . Since Node-Kayles is an impartial game, we can assign a Nimber to every simple graph  $G$ , denoted by  $\mathcal{G}(G)$ . If  $G = \emptyset$  is an empty graph, then the Node-Kayles game on  $\emptyset$  is second-player winning, since the first player loses by having no legal move. Hence,  $\mathcal{G}(\emptyset) = 0$ . For any simple graph  $G$ , the Nimber of the Node-Kayles game on  $G$  is given by

$$\mathcal{G}(G) = \text{mex}\{\mathcal{G}(G_v) : v \in V(G)\},$$

where  $\text{mex}$  represents the “*minimal-excluded rule*”: if  $S$  is a finite subset of  $\mathbb{N} \cup \{0\}$ , then

$$\text{mex}(S) = \min\{\mathbb{N} \cup \{0\} \setminus S\}.$$

Furthermore, if  $G$  is a disjoint union of two simple graphs  $H$  and  $K$ , then

$$\mathcal{G}(G) = \mathcal{G}(H) \oplus \mathcal{G}(K),$$

where  $x \oplus y$  denotes the bitwise XOR between two nonnegative integers  $x$  and  $y$ .

Nimbers will be our main tool in studying Node-Kayles in this paper. In order to familiarize ourselves with this main tool, let us consider a few simple graphs and compute their

respective Nimbers. Let  $P_n$  denote a path with  $n$  vertices. Since  $P_1$  has only one vertex  $v$ , we have  $(P_1)_v = \emptyset$ , and

$$\mathcal{G}(P_1) = \text{mex}\{\mathcal{G}((P_1)_v)\} = \text{mex}\{\mathcal{G}(\emptyset)\} = \text{mex}\{0\} = 1.$$

Since  $P_2$  has only one edge that connects two vertices  $u$  and  $v$ , we have  $(P_2)_u = (P_2)_v = \emptyset$ , and hence

$$\mathcal{G}(P_2) = \text{mex}\{\mathcal{G}(\emptyset)\} = 1.$$

If  $G$  is a graph given by Figure 1, then as seen in Figure 2, the residue subgraphs  $G_{v_1}$ ,  $G_{v_3}$ , and  $G_{v_4}$  are isomorphic to  $P_2$ , while the residue subgraphs  $G_{v_2}$  and  $G_{v_5}$  are isomorphic to  $P_1$ .

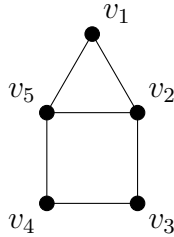

Figure 1: A simple graph  $G$

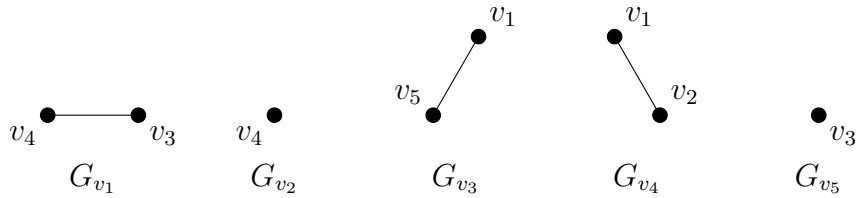

Figure 2: The residue subgraphs  $G_{v_1}$ ,  $G_{v_2}$ ,  $G_{v_3}$ ,  $G_{v_4}$ , and  $G_{v_5}$

Therefore,

$$\mathcal{G}(G) = \text{mex}\{\mathcal{G}(G_{v_i}) : i = 1, 2, 3, 4, 5\} = \text{mex}\{\mathcal{G}(P_1), \mathcal{G}(P_2)\} = \text{mex}\{1, 1\} = 0.$$

Node-Kayles is a generalization of the game of Kayles. Some sources trace the origin of the game of Kayles to the old Dutch game of Kugelspiel [6, p. 232], played with thirteen bowling pins placed in a row, while other sources trace the origin to the French game of *quilles* [4, pp. 118, 220]. Nevertheless, both versions agree on the rules of the game. In the game of Kayles, players alternately bowled, knocking down one pin or two neighboring pins with each throw. The objective of the game was to see who could knock down the last standing pin. Notice that this game is not equivalent to the Node-Kayles on a path; rather, in Section 4, we will prove that the game of Kayles is equivalent to the game of Node-Kayles

on “ $n$ -linked cliques”. Although there is no documented proof on the historical development of the game of Node-Kayles, Simon P. Norton claimed the invention of this game during a personal encounter with the last author of this paper.

There has been literature studying the game of Node-Kayles [5]. Our goal in this paper is to determine the sequence of Nimbers for Node-Kayles on various infinite families of simple graphs. In particular, if  $(G_n : n \in \mathbb{N})$  is a sequence of graphs indexed by natural numbers, then we can define a corresponding *Nimber sequence*  $(\mathcal{G}(G_n) : n \in \mathbb{N})$ . To that end, we begin with paths and their derivatives in Section 2. We then present results on lattice graphs of various sizes in Section 3, and apply the results on prism graphs. Section 4 contains results on chained and linked cliques, while Section 5 studies linked cycles and diamonds. Finally, we present results on other graphs such as hypercubes and generalized Petersen graphs in Section 6.

## 2 Node-Kayles on paths and their derivatives

When we consider an infinite sequence of simple graphs, paths are naturally the first such family that comes to mind. Node-Kayles on paths is well-studied in the literature as the octal game  $\cdot\mathbf{137}$ . An *octal game* is an impartial take-and-break game that involves removing beans from heaps of beans [2]. Each octal game has a specific octal code

$$\cdot\mathbf{d}_1\mathbf{d}_2\mathbf{d}_3\dots,$$

which specifies the set of permissible moves in the take-and-break game. In this code, the  $k$ -th digit  $\mathbf{d}_k$  is the sum of a (possibly empty) subset of  $\{\mathbf{1}, \mathbf{2}, \mathbf{4}\}$ , where

- $\mathbf{1}$  indicates a heap can be completely removed by removing  $k$  beans;
- $\mathbf{2}$  indicates a heap can be reduced into a smaller positive size by removing  $k$  beans; and
- $\mathbf{4}$  indicates a heap can be split into two heaps of smaller positive sizes by removing  $k$  beans.

For example, an octal game  $\cdot\mathbf{137}$  has  $\mathbf{d}_1 = \mathbf{1}$ ,  $\mathbf{d}_2 = \mathbf{3}$ , and  $\mathbf{d}_3 = \mathbf{7}$ , and the code indicates that one can remove one bean from a heap to completely remove that heap; remove two beans from a heap to completely remove that heap or reduce the size of that heap; or remove three beans from a heap to completely remove that heap, reduce the size of that heap, or split that heap into two smaller heaps.

We can now see why Node-Kayles on a path  $P_n$  is equivalent to an octal game  $\cdot\mathbf{137}$ . Recall that each Node-Kayles move requires us to remove a vertex  $v$  together with its neighbors  $N(v)$ ; and after each move, the resulting residue subgraph is a forest, where each connected component is a path of the form  $P_j = v_1v_2\cdots v_j$  for some positive integer  $j$ . Translating to octal games, a connected component  $P_j$  is analogous to a heap of  $j$  beans. The only

way to remove exactly one vertex from  $P_j$  is when  $j = 1$ , thus completely removing the component. Therefore,  $\mathbf{d}_1 = \mathbf{1}$ . There are two ways to remove two vertices from  $P_j$ : we can either completely remove this component when  $j = 2$ , or reduce the length of this path by removing the closed neighborhoods  $N_{(P_j)}[v_1]$  or  $N_{(P_j)}[v_j]$  when  $j \geq 3$ . Therefore,  $\mathbf{d}_2 = \mathbf{1} + \mathbf{2} = \mathbf{3}$ . There are three ways to remove three vertices from  $P_j$ : we can completely remove this component when  $j = 3$ , reduce the length of this path by removing  $N_{P_j}[v_2]$  or  $N_{P_j}[v_{j-1}]$  when  $j \geq 4$ , or split  $P_j$  into two shorter paths by removing  $N_{P_j}[v_i]$ ,  $3 \leq i \leq j - 2$ , when  $j \geq 5$ . Therefore,  $\mathbf{d}_3 = \mathbf{1} + \mathbf{2} + \mathbf{4} = \mathbf{7}$ . Due to this equivalence, the Nimber sequence  $(\mathcal{G}(P_n) : n \in \mathbb{N})$  of paths is the same as the Nimber sequence of the octal game  $\cdot\mathbf{137}$ , which appears on the On-Line Encyclopedia of Integer Sequences (OEIS) as [A002187](#) [7].

Recall that for each positive integer  $m$ , the  $m$ -th power  $G^m$  of a simple graph  $G$  is a new graph on the same vertex set such that two vertices are adjacent in  $G^m$  if and only if their distance in  $G$  is at most  $m$ . It is not difficult to see that Node-Kayles on the square  $(P_n)^2$  and the cube  $(P_n)^3$  of a path are equivalent to octal games  $\cdot\mathbf{11337}$  and  $\cdot\mathbf{1113337}$ , respectively. Hence, the Nimber sequences  $(\mathcal{G}((P_n)^2) : n \in \mathbb{N})$  and  $(\mathcal{G}((P_n)^3) : n \in \mathbb{N})$  are also known, and they appear on the OEIS as [A071426](#) and [A071441](#) [7], respectively.

We can, of course, continue to explore the Nimber sequence  $(\mathcal{G}((P_n)^m) : n \in \mathbb{N})$  when  $m \in \{4, 5, \dots\}$ . Instead, we study a variation of the power of paths. Define an  $m$ -path  $P_n(m)$  as a path  $P_n = v_1v_2 \cdots v_n$  with additional edges  $\{v_iv_j : |i - j| = m\}$ . In this section, we determine the Nimber sequence  $(\mathcal{G}(P_n(3)) : n \in \mathbb{N})$  of 3-paths.

To achieve this, we need to further define two related families of graphs. A  $B$ -version of a 3-path, denoted by  $P_n^B(3)$ , is a 3-path  $P_n(3)$  with an additional vertex  $v_{-1}$ , and if  $n \geq 2$ , an additional edge  $v_{-1}v_2$ . A  $C$ -version of a 3-path, denoted by  $P_n^C(3)$ , is a  $B$ -version of a 3-path  $P_n^B(3)$  with an additional vertex  $v_{n+2}$ , and if  $n \geq 2$ , an additional edge  $v_{n-1}v_{n+2}$ . Figures 3 to 5 are examples of a 3-path, a  $B$ -version of a 3-path, and a  $C$ -version of a 3-path, respectively.

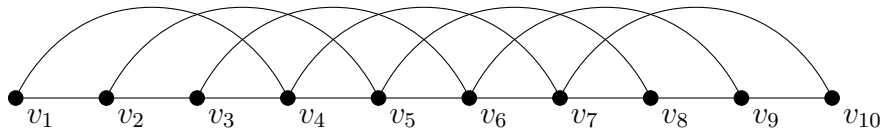

Figure 3: The 3-graph  $P_{10}(3)$

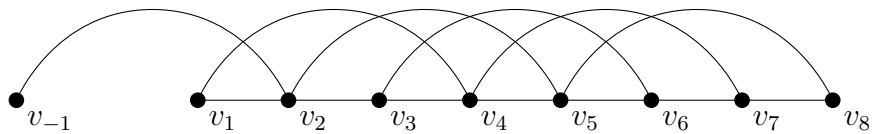

Figure 4: The  $B$ -version of a 3-path  $P_8^B(3)$

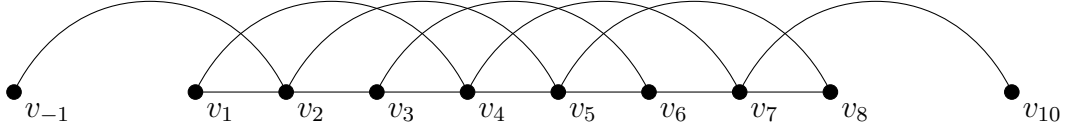

Figure 5: The  $C$ -version of a 3-path  $P_8^C(3)$

To simplify the notation, we define  $A(n) = \mathcal{G}(P_n(3))$ ,  $B(n) = \mathcal{G}(P_n^B(3))$ , and  $C(n) = \mathcal{G}(P_n^C(3))$ . The sequence  $(A(n) : n \in \mathbb{N})$  is now listed on the OEIS as [A317367](#) [7].

**Theorem 1.** *The Nimber sequences  $(A(n) : n \geq 116)$ ,  $(B(n) : n \geq 117)$ , and  $(C(n) : n \geq 118)$  are periodic with period 62.*

*Proof.* By definition,

$$C(n) = \text{mex}\{\mathcal{G}(P_n^C(3)_{v_i}) : i = -1, 1, 2, \dots, n, n+2\}.$$

By the symmetry of  $P_n^C(3)$ , we have

$$C(n) = \text{mex}\{\mathcal{G}(P_n^C(3)_{v_i}) : i = -1, 1, 2, \dots, \lceil n/2 \rceil\}.$$

It is easy to see that  $P_n^C(3)_{v_{-1}}$  has  $v_{-1}$  and  $v_2$  removed, so  $\mathcal{G}(P_n^C(3)_{v_{-1}}) = C(n-2)$ . Similarly, we can easily see that  $\mathcal{G}(P_n^C(3)_{v_i}) = C(i-4) \oplus C(n-i-3)$  for  $5 \leq i \leq \lceil n/2 \rceil$ . To compute  $\mathcal{G}(P_n^C(3)_{v_i})$  for  $1 \leq i \leq 4$ , it is convenient to extend the definition of  $P_n^C(3)$  to cases when  $-3 \leq n \leq 0$  and determine the corresponding  $C(n)$  as follows.

$n$	$P_n^C(3)$	$C(n)$
-3	•	1
-2	$\emptyset$	0
-1	•                      •	0
0		1

In this way, we find the recursion

$$C(n) = \text{mex}(\{C(n-2)\} \cup \{C(i-4) \oplus C(n-i-3) : 1 \leq i \leq \lceil n/2 \rceil\}) \quad (1)$$

for all  $n \in \mathbb{N}$ . Now, we are ready to prove that  $(C(n) : n \geq 118)$  is periodic with period 62 by strong induction.

With recursion (1), together with the initial conditions  $(C(-3), C(-2), C(-1), C(0)) = (1, 0, 0, 1)$ , we can compute the values of the sequence  $(C(n) : 1 \leq n \leq 427)$ , which is periodic with period 62 when  $118 \leq n \leq 427$ . Assume that for some  $n \geq 428$ ,  $C(i) = C(i-62)$  for

all  $180 \leq i < n$ . Then

$$\begin{aligned}
C(n) &= \text{mex} \left( \{C(n-2)\} \cup \{C(i-4) \oplus C(n-i-3) : 1 \leq i \leq \lceil n/2 \rceil - 31\} \right. \\
&\quad \left. \cup \{C(i-4) \oplus C(n-i-3) : \lceil n/2 \rceil - 30 \leq i \leq \lceil n/2 \rceil\} \right) \\
&= \text{mex} \left( \{C((n-62)-2)\} \cup \{C(i-4) \oplus C((n-62)-i-3) : 1 \leq i \leq \lceil (n-62)/2 \rceil\} \right. \\
&\quad \left. \cup \{C(i-4) \oplus C((n-62)-i-3) : \lceil n/2 \rceil - 30 \leq i \leq \lceil n/2 \rceil\} \right) \\
&= \text{mex} \left( \{C((n-62)-2)\} \cup \{C(i-4) \oplus C((n-62)-i-3) : 1 \leq i \leq \lceil (n-62)/2 \rceil\} \right. \\
&\quad \left. \cup \{C(i-4) \oplus C((n-62)-i-3) : \lceil n/2 \rceil - 92 \leq i \leq \lceil n/2 \rceil - 62\} \right) \\
&= \text{mex} \left( \{C((n-62)-2)\} \cup \{C(i-4) \oplus C((n-62)-i-3) : 1 \leq i \leq \lceil (n-62)/2 \rceil\} \right) \\
&= C(n-62),
\end{aligned}$$

which completes our induction.

Next, we study  $B(n)$ . By definition,

$$B(n) = \text{mex} \{ \mathcal{G}(P_n^B(3)_{v_i}) : i = -1, 1, 2, \dots, n \}.$$

Similar to the study of  $C(n)$ , we have  $\mathcal{G}(P_n^B(3)_{v_{-1}}) = B(n-2)$ , and  $\mathcal{G}(P_n^B(3)_{v_i}) = C(i-4) \oplus B(n-i-3)$  for  $1 \leq i \leq n-4$ . Again, it is convenient to extend the definition of  $P_n^B(3)$  to cases when  $-3 \leq n \leq 0$  and determine the corresponding  $B(n)$  as follows.

$n$	$P_n^B(3)$	$B(n)$
-3	$\emptyset$	0
-2	$\emptyset$	0
-1	$\bullet$	1
0	$\bullet$	1

In this way, we find the recursion

$$B(n) = \text{mex} \left( \{B(n-2)\} \cup \{C(i-4) \oplus B(n-i-3) : 1 \leq i \leq n\} \right) \quad (2)$$

for all  $n \in \mathbb{N}$ . Again, we will prove that  $(B(n) : n \geq 117)$  is periodic with period 62 by strong induction.

With recursion (2), together with the initial conditions  $(B(-3), B(-2), B(-1), B(0)) = (0, 0, 1, 1)$  and the sequence  $(C(n) : n \in \mathbb{N})$ , we can compute the values of the sequence  $(B(n) : 1 \leq n \leq 364)$ , which is periodic with period 62 when  $117 \leq n \leq 364$ . Assume that for some  $n \geq 365$ ,  $B(i) = B(i-62)$  for all  $179 \leq i < n$ . Then

$$\begin{aligned}
B(n) &= \text{mex} \left( \{B(n-2)\} \cup \{C(i-4) \oplus B(n-i-3) : 1 \leq i \leq n-182\} \right. \\
&\quad \left. \cup \{C(i-4) \oplus B(n-i-3) : n-181 \leq i \leq n\} \right) \\
&= \text{mex} \left( \{B((n-62)-2)\} \cup \{C(i-4) \oplus B((n-62)-i-3) : 1 \leq i \leq n-182\} \right. \\
&\quad \left. \cup \{C(i-4) \oplus B((n-62)-i-3) : n-243 \leq i \leq n-62\} \right) \\
&= \text{mex} \left( \{B((n-62)-2)\} \cup \{C(i-4) \oplus B((n-62)-i-3) : 1 \leq i \leq n-62\} \right) \\
&= B(n-62),
\end{aligned}$$

which completes our induction.

Finally, we study  $A(n)$ . By definition,

$$A(n) = \text{mex}\{\mathcal{G}(P_n(3)_{v_i}) : i = 1, 2, \dots, n\}.$$

By the symmetry of  $P_n(3)$ , we have

$$A(n) = \text{mex}\{\mathcal{G}(P_n(3)_{v_i}) : i = 1, 2, \dots, \lceil n/2 \rceil\}.$$

Similar to the study of  $B(n)$  and  $C(n)$ , we have  $\mathcal{G}(P_n(3)_{v_i}) = B(i-4) \oplus B(n-i-3)$  for  $1 \leq i \leq \lceil n/2 \rceil$ . Hence, we find the recursion

$$A(n) = \text{mex}(\{B(i-4) \oplus B(n-i-3) : 1 \leq i \leq \lceil n/2 \rceil\}) \quad (3)$$

for all  $n \in \mathbb{N}$ . Once again, we will prove that  $(A(n) : n \geq 116)$  is periodic with period 62 by strong induction.

With recursion (3), together with the sequence  $(B(n) : n \in \mathbb{N})$ , we can compute the values of the sequence  $(A(n) : 1 \leq n \leq 424)$ , which is periodic with period 62 when  $116 \leq n \leq 424$ . Assume that for some  $n \geq 425$ ,  $A(i) = A(i-62)$  for all  $178 \leq i < n$ . Then

$$\begin{aligned} A(n) &= \text{mex}(\{B(i-4) \oplus B(n-i-3) : 1 \leq i \leq \lceil n/2 \rceil - 31\} \\ &\quad \cup \{B(i-4) \oplus B(n-i-3) : \lceil n/2 \rceil - 30 \leq i \leq \lceil n/2 \rceil\}) \\ &= \text{mex}(\{B(i-4) \oplus B((n-62)-i-3) : 1 \leq i \leq \lceil (n-62)/2 \rceil\} \\ &\quad \cup \{B(i-4) \oplus B((n-62)-i-3) : \lceil n/2 \rceil - 92 \leq i \leq \lceil n/2 \rceil - 62\}) \\ &= \text{mex}(\{B(i-4) \oplus B((n-62)-i-3) : 1 \leq i \leq \lceil (n-62)/2 \rceil\}) \\ &= A(n-62), \end{aligned}$$

which completes our induction. □

By computation, we further discover that the sequences  $(A(n) : n \geq 50)$ ,  $(B(n) : n \geq 51)$ , and  $(C(n) : n \geq 52)$  are identical, and their repeating unit  $(A(n) : 116 \leq n \leq 177)$  is given by

$$\begin{aligned} &6, 4, 7, 5, 8, 4, 1, 1, 0, 2, 1, 3, 0, 2, 1, 3, 0, 1, 1, 3, 0, 2, 3, 3, 2, 2, 7, 4, 6, 5, 4, \\ &4, 5, 5, 7, 9, 6, 3, 3, 2, 0, 3, 1, 1, 0, 3, 1, 2, 0, 3, 1, 2, 0, 1, 1, 4, 0, 5, 5, 4, 7, 5. \end{aligned}$$

In particular, the maximum Nimber value is 9, occurring at  $A(151 + 62k)$  for all nonnegative integers  $k$ . Also, when  $n \in \mathbb{N}$ ,  $A(n) = 0$  if and only if

$$n \in \{22, 58\} \text{ or } n \equiv 0, 4, 8, 12, 32, 36, 40, 44, \text{ or } 48 \pmod{62}.$$

Unlike Node-Kayles on the powers of a path, Node-Kayles on a 3-path is not an octal game. Nonetheless, the Nimber sequence  $(A(n) : n \in \mathbb{N})$  for 3-paths is almost identical to that of the octal game **·124**, listed on the OEIS as [A071461](#) [7]. In fact, the two sequences are different at only two positions, namely  $\mathcal{G}(P_{21}(3))$  and  $\mathcal{G}(P_{49}(3))$ . Such level of resemblance seems to indicate some deeper relationship hidden behind the two games.

It is worth noting that the recursions of the three different Nimber sequences, given by equations (1), (2), and (3), are the key to the proof of periodicity of  $(A(n) : n \geq 116)$ . Similar techniques are also employed in subsequent sections.



### 3 Lattice graphs and prism graphs

Apart from the powers of paths, lattice graphs are another natural generalization of paths. In this section, we study the Nimber sequences of some lattice graphs. Define an  $n \times m$  lattice  $L_{n \times m}$  as the Cartesian product  $P_n \square P_m$  with the vertex set  $\{v_{i,j} : 1 \leq i \leq n, 1 \leq j \leq m\}$  and the edge set  $\{v_{i,j}v_{i',j'} : |i - i'| + |j - j'| = 1\}$ . In particular,  $L_{n \times 2}$  is a *ladder graph* with  $n$  “rungs.”

To determine the Nimber sequence  $(\mathcal{G}(L_{n \times 2}) : n \in \mathbb{N})$  of ladder graphs, we need to further define three related families of graphs. The first variation, denoted by  $L_{n \times 2}^-$ , is a ladder graph  $L_{n \times 2}$  with an additional vertex  $v_{n+1,2}$  and an additional edge  $v_{n,2}v_{n+1,2}$ ; the second variation, denoted by  ${}^-L_{n \times 2}^-$ , is the first variation  $L_{n \times 2}^-$  with an additional vertex  $v_{0,2}$  and an additional edge  $v_{0,2}v_{1,2}$ ; and the third variation, denoted by  ${}_^-L_{n \times 2}^-$ , is the first variation  $L_{n \times 2}^-$  with an additional vertex  $v_{0,1}$  and an additional edge  $v_{0,1}v_{1,1}$ . Figures 6 to 9 are examples of a ladder graph, its first variation, second variation, and third variation, respectively.

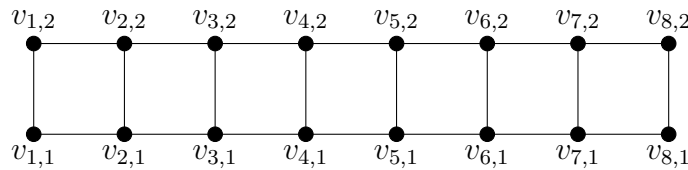

Figure 6: The lattice graph  $L_{8 \times 2}$

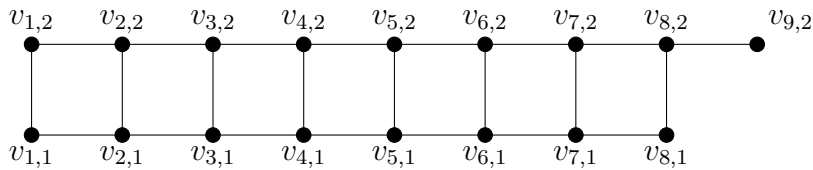

Figure 7: The first variation of the lattice graph  $L_{8 \times 2}^-$

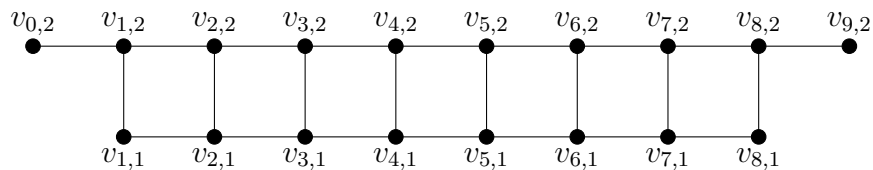

Figure 8: The second variation of the lattice graph  ${}^-L_{8 \times 2}^-$

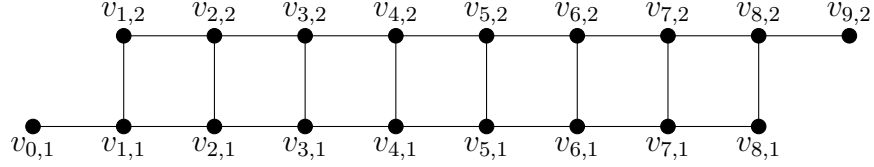

Figure 9: The third variation of the lattice graph  $-L_{8 \times 2}^{-}$

**Theorem 2.** *The Nimber sequences  $(\mathcal{G}(L_{n \times 2}) : n \in \mathbb{N})$ ,  $(\mathcal{G}(L_{n \times 2}^{-}) : n \in \mathbb{N})$ ,  $(\mathcal{G}(-L_{n \times 2}^{-}) : n \in \mathbb{N})$ , and  $(\mathcal{G}(-L_{n \times 2}^{-}) : n \in \mathbb{N})$  are given by the following:*

$$\mathcal{G}(L_{n \times 2}) = \begin{cases} 1, & \text{if } n \text{ is odd;} \\ 0, & \text{otherwise.} \end{cases}$$

and

$$\mathcal{G}(L_{n \times 2}^{-}) = n + 1, \mathcal{G}(-L_{n \times 2}^{-}) = 1, \text{ and } \mathcal{G}(-L_{n \times 2}^{-}) = 0$$

for all  $n \in \mathbb{N}$ .

*Proof.* First, note that  $L_{1 \times 2}$ ,  $L_{1 \times 2}^{-}$ , and  $-L_{1 \times 2}^{-}$  are isomorphic to paths  $P_2$ ,  $P_3$ , and  $P_4$ , respectively, so  $\mathcal{G}(L_{1 \times 2}) = \mathcal{G}(P_2) = 1$ ,  $\mathcal{G}(L_{1 \times 2}^{-}) = \mathcal{G}(P_3) = 2$ , and  $\mathcal{G}(-L_{1 \times 2}^{-}) = \mathcal{G}(P_4) = 0$  from the Nimber sequence of the octal game **137**. We can also easily see that  $\mathcal{G}(-L_{1 \times 2}^{-}) = \text{mex}\{1 \oplus 1, 0\} = \text{mex}\{0, 0\} = 1$ . Hence, the base cases for our strong induction are true.

Before we proceed with our induction proof, it is convenient to extend the definitions of  $L_{n \times 2}^{-}$ ,  $-L_{n \times 2}^{-}$ , and  $-L_{n \times 2}^{-}$  to cases when  $-1 \leq n \leq 0$  and determine the corresponding Nimbers as follows.

$n$	$L_{n \times 2}^{-}$	$\mathcal{G}(L_{n \times 2}^{-})$	$-L_{n \times 2}^{-}$	$\mathcal{G}(-L_{n \times 2}^{-})$	$-L_{n \times 2}^{-}$	$\mathcal{G}(-L_{n \times 2}^{-})$
-1	$\emptyset$	$0 = n + 1$	$\bullet$	1	$\emptyset$	0
0	$\bullet$	$1 = n + 1$	$\bullet \text{---} \bullet$	1	$\bullet$	0

Now, we are ready to finish our proof by strong induction. Assume that for some integer  $n \geq 2$ ,

$$\mathcal{G}(L_{i \times 2}^{-}) = i + 1, \mathcal{G}(-L_{i \times 2}^{-}) = 1, \text{ and } \mathcal{G}(-L_{i \times 2}^{-}) = 0$$

for all integers  $-1 \leq i < n$ . To find  $\mathcal{G}(L_{n \times 2})$ , we exhaust all possible first moves in the Node-Kayles game on  $L_{n \times 2}$ . For each  $1 \leq i \leq n$ ,

$$\mathcal{G}((L_{n \times 2})_{v_{i,1}}) = \mathcal{G}((L_{n \times 2})_{v_{i,2}}) = \mathcal{G}(L_{(i-2) \times 2}^{-}) \oplus \mathcal{G}(L_{(n-i-1) \times 2}^{-}) = (i-1) \oplus (n-i).$$

Note that  $(i-1) \oplus (n-i) = 0$  if and only if  $i-1 = n-i$ , which occurs precisely when  $n$  is odd. Moreover,  $(i-1) \oplus (n-i) = 1$  if and only if  $i-1$  is even and  $n-i = (i-1) + 1$ , or  $n-i$  is even and  $i-1 = (n-i) + 1$ , and either case occurs precisely when  $n$  is even. Therefore,

if  $n$  is odd, then  $\{\mathcal{G}((L_{n \times 2})_v) : v \in V(L_{n \times 2})\}$  contains 0 but not 1, implying that  $\mathcal{G}(L_{n \times 2}) = \text{mex}\{\mathcal{G}((L_{n \times 2})_v) : v \in V(L_{n \times 2})\} = 1$ ; if  $n$  is even, then  $\{\mathcal{G}((L_{n \times 2})_v) : v \in V(L_{n \times 2})\}$  does not contain 0, implying that  $\mathcal{G}(L_{n \times 2}) = \text{mex}\{\mathcal{G}((L_{n \times 2})_v) : v \in V(L_{n \times 2})\} = 0$ .

Similar to the proof technique above, we list out the Nimber of the Node-Kayles game on the residue subgraph  $(L_{n \times 2}^-)_v$  for each vertex  $v$  in the following table.

Vertex $v$	$\mathcal{G}((L_{n \times 2}^-)_v)$
$v_{i,1}$ , where $1 \leq i \leq n$	$\mathcal{G}(L_{(i-2) \times 2}^-) \oplus \mathcal{G}(-L_{(n-i-1) \times 2}^-) = (i-1) \oplus 1$
$v_{i,2}$ , where $1 \leq i \leq n$	$\mathcal{G}(L_{(i-2) \times 2}^-) \oplus \mathcal{G}(-L_{(n-i-1) \times 2}^-) = (i-1) \oplus 0 = i-1$
$v_{n+1,2}$	$\mathcal{G}(L_{(n-1) \times 2}^-) = n$

Note that for  $1 \leq i \leq n$ , the quantity  $(i-1) \oplus 1 = i-2$  if  $i$  is even and  $(i-1) \oplus 1 = i$  if  $i$  is odd. Therefore,

$$\begin{aligned} \mathcal{G}(L_{n \times 2}^-) &= \text{mex}(\{i-2 : 1 \leq i \leq n \text{ and } i \text{ is even}\} \cup \{i : 1 \leq i \leq n \text{ and } i \text{ is odd}\} \\ &\quad \cup \{i-1 : 1 \leq i \leq n\} \cup \{n\}) \\ &= \text{mex}\{0, 1, 2, \dots, n\} = n+1. \end{aligned}$$

To find  $\mathcal{G}(-L_{n \times 2}^-)$ , we create the following table.

Vertex $v$	$\mathcal{G}((-L_{n \times 2}^-)_v)$
$v_{i,1}$ , where $1 \leq i \leq n$	$\mathcal{G}(-L_{(i-2) \times 2}^-) \oplus \mathcal{G}(-L_{(n-i-1) \times 2}^-) = 1 \oplus 1 = 0$
$v_{i,2}$ , where $1 \leq i \leq n$	$\mathcal{G}(-L_{(i-2) \times 2}^-) \oplus \mathcal{G}(-L_{(n-i-1) \times 2}^-) = 0 \oplus 0 = 0$
$v_{0,2}$ or $v_{n+1,2}$	$\mathcal{G}(-L_{(n-1) \times 2}^-) = 0$

Therefore,  $\mathcal{G}(-L_{n \times 2}^-) = \text{mex}\{0\} = 1$ .

Finally, to find  $\mathcal{G}(-L_{n \times 2}^-)$ , we create the following table.

Vertex $v$	$\mathcal{G}((-L_{n \times 2}^-)_v)$
$v_{i,1}$ , where $1 \leq i \leq n$	$\mathcal{G}(-L_{(i-2) \times 2}^-) \oplus \mathcal{G}(-L_{(n-i-1) \times 2}^-) = 0 \oplus 1 = 1$
$v_{i,2}$ , where $1 \leq i \leq n$	$\mathcal{G}(-L_{(i-2) \times 2}^-) \oplus \mathcal{G}(-L_{(n-i-1) \times 2}^-) = 1 \oplus 0 = 1$
$v_{0,1}$ or $v_{n+1,2}$	$\mathcal{G}(-L_{(n-1) \times 2}^-) = 1$

Therefore,  $\mathcal{G}(-L_{n \times 2}^-) = \text{mex}\{1\} = 0$ , and this completes the induction.  $\square$

An immediate application of the proof of Theorem 2 is the following corollary on prism graphs. For any integer  $n \geq 3$ , a *prism* of order  $n$ , denoted by  $\Pi_n$ , is the Cartesian product  $C_n \square P_2$ . It is essentially a circular ladder with the vertex set  $\{v_{i,j} : 1 \leq i \leq n, 1 \leq j \leq 2\}$  and the edge set  $\{v_{i,j}v_{i',j'} : |i-i'| + |j-j'| = 1\} \cup \{v_{1,1}v_{n,1}, v_{1,2}v_{n,2}\}$ .

**Corollary 3.** *The Nimber sequence  $(\mathcal{G}(\Pi_n) : n \geq 3)$  is constantly 0.*

*Proof.* After any move of the first player, the residue graph is always isomorphic to  ${}^-L_{(n-3) \times 2}^-$ . From the proof of Theorem 2,  $\mathcal{G}({}^-L_{(n-3) \times 2}^-) = 1$  for all integers  $n \geq 3$ . Therefore,  $\mathcal{G}(\Pi_n) = \text{mex}\{\mathcal{G}((\Pi_n)_v) : v \in V(\Pi_n)\} = \text{mex}\{1\} = 0$ .  $\square$

Similar to the proof of Theorem 1, the technique in the proof of Theorem 2 is to recursively compute the Nimbers of residue graphs. This technique is efficient since most residue graphs of 3-paths and ladder graphs are disconnected, and each connected component is always one of the few variations of the original graphs. Unfortunately, many residue graphs of lattices  $L_{n \times m}$  are connected when  $n$  and  $m$  are greater than 2. As a result, this method is far too tedious to be applied to larger lattice graphs. For example, to determine the Nimber of the Node-Kayles game on  $L_{3 \times 3}$ , we need to first find that

$$\begin{aligned} \mathcal{G}(\text{graph}) &= \text{mex}\{\mathcal{G}(\text{graph}_1), \mathcal{G}(\text{graph}_2), \mathcal{G}(\text{graph}_3), \mathcal{G}(\text{graph}_4), \mathcal{G}(\text{graph}_5), \mathcal{G}(\text{graph}_6)\} \\ &= \text{mex}\{\mathcal{G}(-L_{1 \times 2}^-), \mathcal{G}(P_2), 1 \oplus 1 \oplus 1, 1 \oplus 1 \oplus 1, \mathcal{G}(P_2), \mathcal{G}(-L_{1 \times 2}^-)\} \\ &= \text{mex}\{1, 1, 1, 1, 1, 1\} = 0, \end{aligned}$$

before we find

$$\begin{aligned} \mathcal{G}(L_{3 \times 3}) &= \text{mex}\{\mathcal{G}(\text{graph}_1), \mathcal{G}(\text{graph}_2), \mathcal{G}(\text{graph}_3)\} \\ &= \text{mex}\{0, \mathcal{G}(P_5), 1 \oplus 1 \oplus 1 \oplus 1\} = \text{mex}\{0, 3, 0\} = 1. \end{aligned}$$

The complexity of this process drastically increases when we try to determine  $\mathcal{G}(L_{5 \times 3})$  with this method. Hence, in order to study the Nimber sequence of the Node-Kayles game on lattice graphs in general, we need to adopt another approach.

Recall from the introduction that the Nimber of an impartial game is 0 if and only if it is second-player winning. The following theorem specifies graphs with a special property that will guarantee a winning strategy for the second-player. This theorem also appears in the work of Duchêne et. al. [3], but the proof is included here for completion.

**Theorem 4.** *Let  $G$  be a simple graph. If there exists a graph involution  $\varphi$  on  $G$  such that for all  $v \in V(G)$ ,  $\varphi(v)$  is neither  $v$  nor a neighbor of  $v$  in  $G$ , then  $\mathcal{G}(G) = 0$ .*

*Proof.* In the first player's initial move, if the closed neighborhood  $N_G[v]$  of a vertex  $v$  is removed from  $G$ , then the strategy of the second player is to remove  $N_G[\varphi(v)]$  from  $G$ . Note that this move is legal since  $\varphi(v)$  cannot be removed by the first player, as  $\varphi(v) \notin N_G[v]$ .

Denote the residue graph after the second player's initial move as

$$H := G - (N_G[v] \cup N_G[\varphi(v)]).$$

Note that for every vertex  $u \in H$ , since  $u \notin N_G[v]$ ,  $\varphi(u) \notin N_G[\varphi(v)]$ . Also, since  $u \notin N_G[\varphi(v)]$ ,  $\varphi(u) \notin N_G[\varphi^2(v)] = N_G[v]$ . Hence,  $\varphi(u) \in H$ , and  $\varphi|_H$  is a well-defined graph homomorphism. As a result,  $\varphi|_H$  is a graph involution on  $H$  such that for all  $u \in V(H)$ ,  $\varphi(u)$  is neither  $u$  nor a neighbor of  $u$  in  $G$ . Hence, we can inductively apply the strategy described above.  $\square$

We are going to apply Theorem 4 on some lattice graphs.

**Theorem 5.** *The Nimber  $\mathcal{G}(L_{n \times m})$  is 0 if both  $n$  and  $m$  are even, and is positive if both  $n$  and  $m$  are odd.*

*Proof.* If both  $n$  and  $m$  are even, then let  $\varphi$  be a graph automorphism on  $L_{n \times m}$  such that  $\varphi(v_{i,j}) = v_{n+1-i, m+1-j}$ . Essentially,  $\varphi$  rotates the lattice graph by  $180^\circ$ . It is easy to check that  $\varphi$  is an involution that satisfies the condition in Theorem 4, so  $\mathcal{G}(L_{n \times m}) = 0$ .

If both  $n$  and  $m$  are odd, then let  $\varphi$  be a graph automorphism on  $(L_{n \times m})_{v_{\frac{n+1}{2}, \frac{m+1}{2}}}$  such that  $\varphi(v_{i,j}) = v_{n+1-i, m+1-j}$ . Once again,  $\varphi$  is an involution that satisfies the condition in Theorem 4, so  $\mathcal{G}((L_{n \times m})_{v_{\frac{n+1}{2}, \frac{m+1}{2}}}) = 0$ . As a result,  $\{\mathcal{G}((L_{n \times m})_v) : v \in V(L_{n \times m})\}$  contains 0, and hence,  $\mathcal{G}(L_{n \times m}) = \text{mex}\{\mathcal{G}((L_{n \times m})_v) : v \in V(L_{n \times m})\} > 0$ .  $\square$

The winning strategy given by the graph involution described in Theorem 4 is by no means the only one. In particular, we find another winning strategy for the second player on lattice graphs  $L_{n \times 4}$  in the following theorem.

**Theorem 6.** *For all positive integers  $n$ ,  $\mathcal{G}(L_{n \times 4}) = 0$ .*

*Proof.* Define property  $(P)$  of a graph as follows: for any  $1 \leq i \leq n$  and  $1 \leq j \leq 4$ , the vertex  $v_{i,j}$  is in the graph if and only if the vertex  $v_{i, j+2}$  is in the graph, where  $j+2$  is performed under modulo 4.

At the beginning of the game, the lattice graph  $L_{n \times 4}$  clearly satisfies property  $(P)$ . After any move of the first player, if the closed neighborhood  $N_{(L_{n \times 4})}[v_{i,j}]$  of the vertex  $v_{i,j}$  is removed from  $L_{n \times 4}$ , then the strategy of the second player is to remove  $N_{(L_{n \times 4})}[v_{i, j+2}]$ , where  $j+2$  is performed under modulo 4. After the move of the second player, note that the residue graph still satisfies property  $(P)$ . As a result, the second player can win the Node-Kayles game by inductively applying the strategy described above.  $\square$

Table 1 summarizes our results on the Nimbers  $\mathcal{G}(L_{n \times m})$  for  $1 \leq n, m \leq 10$ . Note that the values in shaded cells are computed using Python. The computer code, together with the first few terms in the sequence  $(\mathcal{G}(L_{n \times 3}) : n \in \mathbb{N})$ , are listed on the OEIS as [A316632](#) [7].

$m \backslash n$	1	2	3	4	5	6	7	8	9	10
1	1	1	2	0	3	1	1	0	3	3
2	1	0	1	0	1	0	1	0	1	0
3	2	1	1	0	3	3	2	2	2	3
4	0	0	0	0	0	0	0	0	0	0
5	3	1	3	0	3	3	2		> 0	
6	1	0	3	0	3	0		0		0
7	1	1	2	0	2		> 0		> 0	
8	0	0	2	0		0		0		0
9	3	1	2	0	> 0		> 0		> 0	
10	3	0	3	0		0		0		0

Table 1: Table of Nimbers  $\mathcal{G}(L_{n \times m})$ , where shaded cells are computed using Python

## 4 Chained and linked cliques

In this section, we consider infinite families of graphs constructed using cliques as building blocks. An  $n$ -chained clique, denoted by  $CK_n$ , is a graph with  $n$  cliques  $\{K_{i_j} : 1 \leq j \leq n\}$  linked together such that

- (a)  $V(K_{i_j}) \cap V(K_{i_{j'}}) \neq \emptyset$  if and only if  $|j - j'| = 1$ , and
- (b)  $V(K_{i_j}) \setminus \left(\bigcup_{j' \neq j} V(K_{i_{j'}})\right) \neq \emptyset$  if and only if  $j = 1$  or  $n$ .

If condition (b) is replaced by

- (c)  $V(K_{i_j}) \setminus \left(\bigcup_{j' \neq j} V(K_{i_{j'}})\right) \neq \emptyset$  for  $1 \leq j \leq n$ ,

then the resultant graph is called an  $n$ -linked clique, denoted by  $LK_n$ . Note that in an  $n$ -chained clique, conditions (a) and (b) imply that  $i_j \geq 2$  for all  $1 \leq j \leq n$ , while in an  $n$ -linked clique, conditions (a) and (c) imply that  $i_j \geq 3$  for all  $2 \leq j \leq n - 1$ .

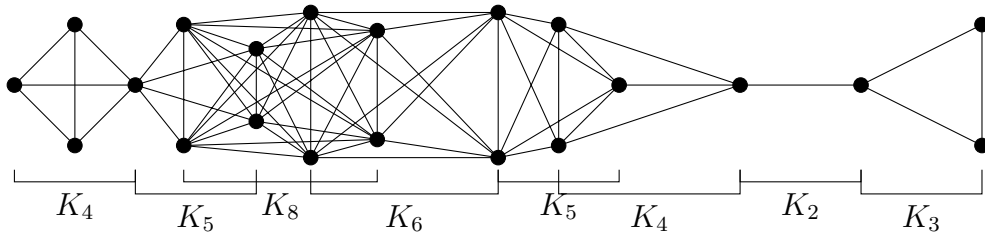

Figure 10: An 8-chained clique that chains up  $K_4, K_5, K_8, K_6, K_5, K_4, K_2, K_3$

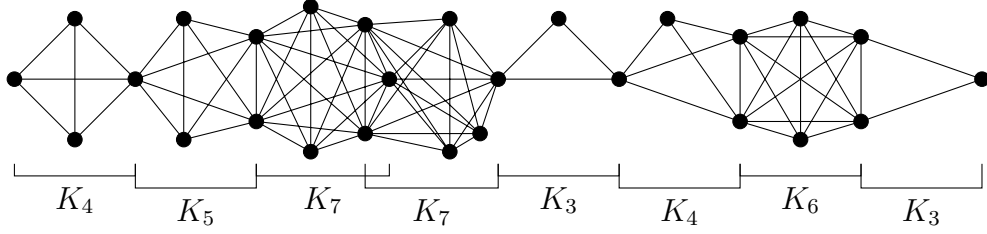

Figure 11: An 8-linked clique that links up  $K_4, K_5, K_7, K_7, K_3, K_4, K_6, K_3$

When we try to analyze the Node-Kayles game on the  $n$ -chained cliques, we discover that the Nimber sequence is quite familiar to us. In fact, for any vertex  $v$  in  $V(K_{i_j}) \cap V(K_{i_{j+1}})$ ,  $1 \leq j \leq n - 1$ , the set of neighbors  $N(v)$  is exactly  $V(K_{i_j}) \cup V(K_{i_{j+1}})$ . Hence, collapsing each of  $V(K_{i_1}) \setminus V(K_{i_2})$ ,  $V(K_{i_j}) \cap V(K_{i_{j+1}})$  with  $1 \leq j \leq n - 1$ , and  $V(K_{i_n}) \setminus V(K_{i_{n-1}})$  to a single vertex yields a graph whose Node-Kayles game is equivalent to the original  $n$ -chained clique. This resultant collapsed graph is precisely the path graph  $P_{n+1}$ , which implies that  $\mathcal{G}(CK_n) = \mathcal{G}(P_{n+1})$  for all  $n \in \mathbb{N}$ .

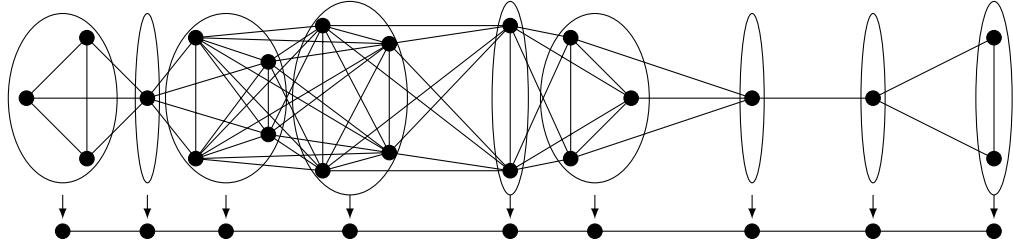

Figure 12: Transforming a  $CK_8$  to  $P_9$

As for  $LK_n$ , note that for any vertex  $v$  in  $V(K_{i_j}) \setminus \left( \bigcup_{j' \neq j} V(K_{i_{j'}}) \right)$ , where  $1 \leq j \leq n$ , the set of neighbors  $N(v)$  is  $V(K_{i_j})$ , and for any vertex  $u$  in  $V(K_{i_j}) \cap V(K_{i_{j+1}})$ , where  $1 \leq j \leq n - 1$ , the set of neighbors  $N(u)$  is  $V(K_{i_j}) \cup V(K_{i_{j+1}})$ . Hence, collapsing each of  $V(K_{i_j}) \setminus \left( \bigcup_{j' \neq j} V(K_{i_{j'}}) \right)$  with  $1 \leq j \leq n$  and  $V(K_{i_j}) \cap V(K_{i_{j+1}})$  with  $1 \leq j \leq n - 1$  to a single vertex yields a graph whose Node-Kayles game is equivalent to the original  $n$ -linked clique. This resultant collapsed graph is an  $n$ -linked clique that links up  $n - 2$  copies of  $K_3$  with a copy of  $K_2$  on each end. To be precise, the vertex set of this resultant graph is  $\{v_1, v_2, \dots, v_n, u_1, u_2, \dots, u_{n-1}\}$ , and the edge set is  $\{v_j u_j, u_j v_{j+1} : 1 \leq j \leq n - 1\} \cup \{u_j u_{j+1} : 1 \leq j \leq n - 2\}$ . We call this graph a *triangular path*, denoted by  $T_n$ , despite each of the two ends of the triangular path has a pendant vertex.

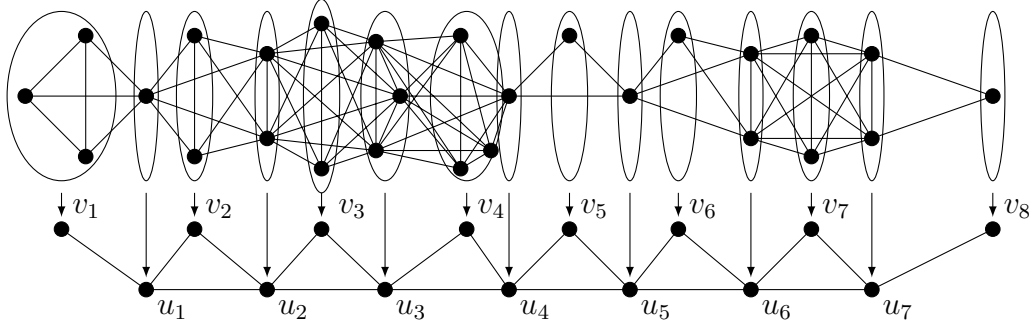

Figure 13: Transforming an  $LK_8$  to  $T_8$

To find  $\mathcal{G}(T_n)$ , we first extend the definition of  $T_n$  to include the case  $n = 0$ , where  $T_0$  is defined as the empty graph. Next, we exhaust all possible first moves in the Node-Kayles game on  $T_n$  and obtain the following recursions.

$$\begin{cases} \mathcal{G}((T_n)_{v_j}) = \mathcal{G}(T_{j-1}) \oplus \mathcal{G}(T_{n-j}), & \text{for } 1 \leq j \leq n; \\ \mathcal{G}((T_n)_{u_j}) = \mathcal{G}(T_{j-1}) \oplus \mathcal{G}(T_{n-j-1}), & \text{for } 1 \leq j \leq n-1. \end{cases} \quad (4)$$

Recursions (4) are identical to the recursion given by the game of Kayles, introduced in Section 1, and both games are equivalent to an octal game  $\cdot 77$ . The equivalence can be seen by identifying  $T_n$  as a heap of  $n$  beans, where each  $v_j$  is a bean. Removing exactly one bean can be performed by removing  $N_{(T_n)}[v_j]$  from  $T_n$  in the Node-Kayles game, and such action may completely remove the heap if  $n = j = 1$ , may reduce the size of the heap if  $n \geq 2$  and  $j = 1$  or  $n$ , and may split the heap into two smaller heaps if  $n \geq 3$  and  $2 \leq j \leq n-1$ ; so  $\mathbf{d}_1 = 7$ . Removing exactly two beans can be performed by removing  $N_{(T_n)}[u_j]$  from  $T_n$  in the Node-Kayles game, and such action may completely remove the heap if  $n = 2$  and  $j = 2$ , may reduce the size of the heap if  $n \geq 3$  and  $j = 1$  or  $n-1$ , and may split the heap into two smaller heaps if  $n \geq 4$  and  $2 \leq j \leq n-2$ ; so  $\mathbf{d}_2 = 7$ . Finally, it is easy to see that it is impossible to remove three or more beans in one move.

In conclusion, the Nimber sequence  $(\mathcal{G}(LK_n) : n \in \mathbb{N}) = (\mathcal{G}(T_n) : n \in \mathbb{N})$  is given by the OEIS sequence [A002186](#) [7].

## 5 Linked cycles and linked diamonds

In the previous section, we constructed the triangular path  $T_n$  (see Figure 13). Clearly, for the purpose of studying the Node-Kayles game, replacing the pendant edge on each end of  $T_n$  by a triangle does not change the game. Triangles, in the previous section, were treated as complete graphs, but we can also think of them as cycles. In this section, we consider infinite families of graphs constructed using cycles of the same length as building blocks. An  $(\ell, n)$ -linked  $k$ -cycle, denoted by  $(C_k)_{\ell, n}$ , is a graph with  $n$  copies of  $C_k$  linked together at vertices  $u_i$ ,  $1 \leq i \leq n-1$ , such that the distance between  $u_i$  and  $u_{i+1}$  is  $\ell$ . To be precise,



to form an  $(\ell, n)$ -linked  $k$ -cycle  $(C_k)_{\ell, n}$ , we begin with a collection of  $n$  copies of  $k$ -cycles  $\{v_{i,0}v_{i,1}v_{i,2}\cdots v_{i,k-1}v_{i,0} : 1 \leq i \leq n\}$ , and we identify vertices such that  $v_{i,\ell} = v_{i+1,0} = u_i$  for all  $1 \leq i \leq n-1$ . The vertex  $v_{n,\ell}$  will also be called  $v_{n+1,0}$ .

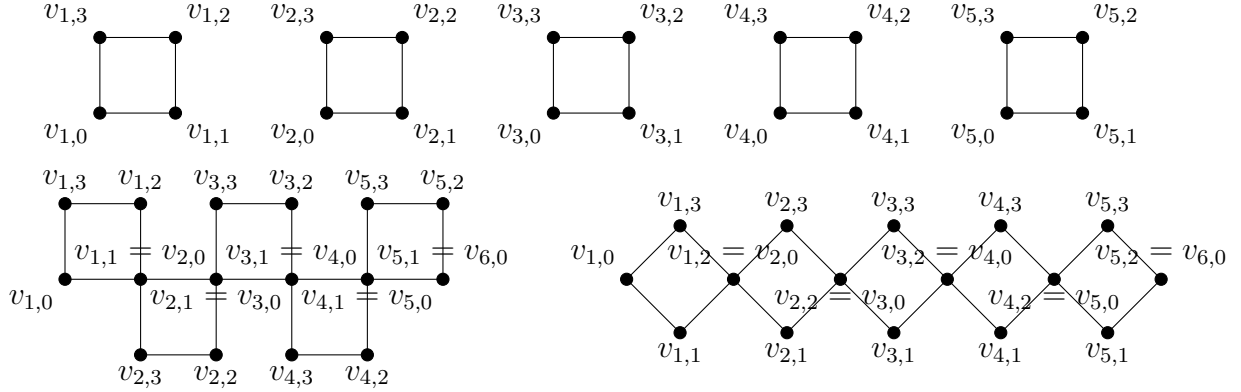

Figure 14: Linking 5 copies of  $C_4$  (top) as  $(C_4)_{1,5}$  (bottom left) or  $(C_4)_{2,5}$  (bottom right)

In this section, we completely determine the Nimber sequences  $(\mathcal{G}((C_4)_{2,n}) : n \in \mathbb{N})$  and  $(\mathcal{G}((C_5)_{2,n}) : n \in \mathbb{N})$ . We will also study the recursion of the Nimber sequence  $(\mathcal{G}((C_4)_{1,n}) : n \in \mathbb{N})$ ; however, this recursion does not give us a closed form, which is mildly surprising.

To determine the Nimber sequence  $(\mathcal{G}((C_4)_{2,n}) : n \in \mathbb{N})$ , we need to further define two related families of graphs. The first variation, denoted by  $(C_4)_{2,n}^<$ , is a  $(2, n)$ -linked 4-cycle with additional vertices  $v_{n+1,1}$  and  $v_{n+1,3}$  and additional edges  $v_{n,2}v_{n+1,1}$  and  $v_{n,2}v_{n+1,3}$ ; the second variation, denoted by  $(C_4)_{2,n}^>$ , is the first variation  $(C_4)_{2,n}^<$  with additional vertices  $v_{0,1}$  and  $v_{0,3}$  and additional edges  $v_{0,1}v_{1,0}$  and  $v_{0,3}v_{1,0}$ . Figures 15 and 16 are examples of the first and second variations of a  $(2, n)$ -linked 4-cycle, respectively.

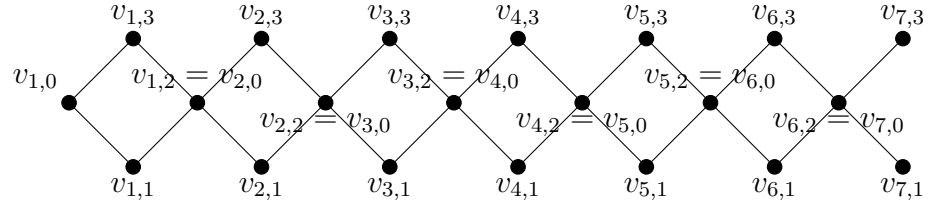

Figure 15: The first variation of the  $(2, 6)$ -linked 4-cycle  $(C_4)_{2,6}^<$

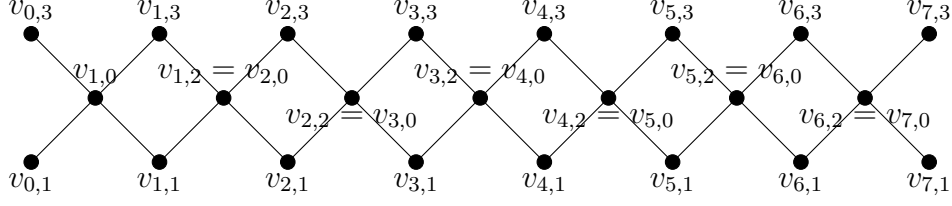

Figure 16: The second variation of the  $(2, 6)$ -linked 4-cycle  $\succ(C_4)_{2,6}^{\leq}$

**Theorem 7.** *The Nimber sequences  $(\mathcal{G}((C_4)_{2,n}) : n \in \mathbb{N})$ ,  $(\mathcal{G}((C_4)_{2,n}^{\leq}) : n \in \mathbb{N})$ , and  $(\mathcal{G}(\succ(C_4)_{2,n}^{\leq}) : n \in \mathbb{N})$  are given by the following:*

$$\mathcal{G}((C_4)_{2,n}) = \begin{cases} 0, & \text{if } n \text{ is odd;} \\ 1, & \text{otherwise} \end{cases}$$

and

$$\mathcal{G}((C_4)_{2,n}^{\leq}) = \mathcal{G}(\succ(C_4)_{2,n}^{\leq}) = \begin{cases} 0, & \text{if } n \text{ is odd;} \\ 2, & \text{otherwise.} \end{cases}$$

*Proof.* First, note that  $(C_4)_{2,1}$  is isomorphic to the lattice graph  $L_{2 \times 2}$ , so  $\mathcal{G}((C_4)_{2,1}) = \mathcal{G}(L_{2 \times 2}) = 0$  by Theorem 2. We can also easily see that

$$\begin{aligned} \mathcal{G}((C_4)_{2,1}^{\leq}) &= \mathcal{G}(\text{graph}) = \text{mex}\{\mathcal{G}(\text{graph}), \mathcal{G}(\text{graph}), \mathcal{G}(\text{graph}), \mathcal{G}(\text{graph})\} \\ &= \text{mex}\{\mathcal{G}(P_3), 1 \oplus 1 \oplus 1, 1, \mathcal{G}(P_3) \oplus 1\} \\ &= \text{mex}\{2, 1, 1, 3\} = 0, \end{aligned}$$

and

$$\begin{aligned} \mathcal{G}(\succ(C_4)_{2,1}^{\leq}) &= \mathcal{G}(\text{graph}) = \text{mex}\{\mathcal{G}(\text{graph}), \mathcal{G}(\text{graph}), \mathcal{G}(\text{graph})\} \\ &= \text{mex}\{1 \oplus \text{mex}\{\mathcal{G}(\text{graph}), \mathcal{G}(\emptyset)\}, \mathcal{G}(P_3), 1 \oplus 1 \oplus 1 \oplus 1 \oplus 1\} \\ &= \text{mex}\{1 \oplus 2, 2, 1\} = 0. \end{aligned}$$

Hence, the base cases for our strong induction are true.

Before we proceed with our induction proof, it is convenient to extend the definitions of  $(C_4)_{2,n}$ ,  $(C_4)_{2,n}^{\leq}$ , and  $\succ(C_4)_{2,n}^{\leq}$  to the cases when  $-1 \leq n \leq 0$  and determine the corresponding Nimbers as follows.

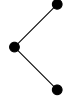
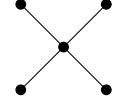
$n$	$(C_4)_{2,n}$	$\mathcal{G}((C_4)_{2,n})$	$(C_4)_{2,n}^<$	$\mathcal{G}((C_4)_{2,n}^<)$	$>(C_4)_{2,n}^<$	$\mathcal{G}(>(C_4)_{2,n}^<)$
-1	$\emptyset$	0	$\emptyset$	0	$\bullet$	0
0	$\bullet$	1		2		2

Now, we are ready to finish our proof by strong induction. Assume that for some integer  $n \geq 2$ ,

$$\mathcal{G}((C_4)_{2,i}) = \begin{cases} 0, & \text{if } n \text{ is odd;} \\ 1, & \text{otherwise} \end{cases}$$

and

$$\mathcal{G}((C_4)_{2,i}^<) = \mathcal{G}(>(C_4)_{2,i}^<) = \begin{cases} 0, & \text{if } n \text{ is odd;} \\ 2, & \text{otherwise} \end{cases}$$

for all integers  $-1 \leq i < n$ . To find  $\mathcal{G}((C_4)_{2,n})$ , we exhaust all possible first moves in the Node-Kayles game on  $(C_4)_{2,n}$ . For each  $1 \leq i \leq n+1$ ,

$$\begin{aligned} \mathcal{G}(((C_4)_{2,n})_{v_{i,0}}) &= \mathcal{G}((C_4)_{2,i-2}) \oplus \mathcal{G}((C_4)_{2,n-i}) \\ &= \begin{cases} 0 \oplus 1 \text{ or } 1 \oplus 0, & \text{if } n \text{ is odd;} \\ 0 \oplus 0 \text{ or } 1 \oplus 1, & \text{otherwise} \end{cases} \\ &= \begin{cases} 1, & \text{if } n \text{ is odd;} \\ 0, & \text{otherwise,} \end{cases} \end{aligned}$$

and for  $1 \leq i \leq n$ ,

$$\begin{aligned} \mathcal{G}(((C_4)_{2,n})_{v_{i,1}}) &= \mathcal{G}(((C_4)_{2,n})_{v_{i,3}}) = \mathcal{G}((C_4)_{2,i-2}^<) \oplus 1 \oplus \mathcal{G}((C_4)_{2,n-i-1}^<) \\ &= \begin{cases} 0 \oplus 1 \oplus 0 \text{ or } 2 \oplus 1 \oplus 2, & \text{if } n \text{ is odd;} \\ 0 \oplus 1 \oplus 2 \text{ or } 2 \oplus 1 \oplus 0, & \text{otherwise} \end{cases} \\ &= \begin{cases} 1, & \text{if } n \text{ is odd;} \\ 3, & \text{otherwise.} \end{cases} \end{aligned}$$

Therefore,

$$\mathcal{G}((C_4)_{2,n}) = \begin{cases} \text{mex}\{1, 1\}, & \text{if } n \text{ is odd;} \\ \text{mex}\{0, 3\}, & \text{otherwise} \end{cases} = \begin{cases} 0, & \text{if } n \text{ is odd;} \\ 1, & \text{otherwise.} \end{cases}$$

To find  $\mathcal{G}((C_4)_{2,n}^<)$ , we exhaust all possible first moves in the Node-Kayles game on  $(C_4)_{2,n}^<$ .

For each  $1 \leq i \leq n + 1$ ,

$$\begin{aligned} \mathcal{G}(((C_4)_{2,n}^{\leq})_{v_{i,0}}) &= \mathcal{G}((C_4)_{2,i-2}) \oplus \mathcal{G}((C_4)_{2,n-i}^{\leq}) \\ &= \begin{cases} 0 \oplus 2 \text{ or } 1 \oplus 0, & \text{if } n \text{ is odd;} \\ 0 \oplus 0 \text{ or } 1 \oplus 2, & \text{otherwise} \end{cases} \\ &= \begin{cases} 2 \text{ or } 1, & \text{if } n \text{ is odd;} \\ 0 \text{ or } 3, & \text{otherwise,} \end{cases} \end{aligned}$$

for  $1 \leq i \leq n$ ,

$$\begin{aligned} \mathcal{G}(((C_4)_{2,n}^{\leq})_{v_{i,1}}) &= \mathcal{G}(((C_4)_{2,n}^{\leq})_{v_{i,3}}) = \mathcal{G}((C_4)_{2,i-2}^{\leq}) \oplus 1 \oplus \mathcal{G}(>(C_4)_{2,n-i-1}^{\leq}) \\ &= \begin{cases} 0 \oplus 1 \oplus 0 \text{ or } 2 \oplus 1 \oplus 2, & \text{if } n \text{ is odd;} \\ 0 \oplus 1 \oplus 2 \text{ or } 2 \oplus 1 \oplus 0, & \text{otherwise} \end{cases} \\ &= \begin{cases} 1, & \text{if } n \text{ is odd;} \\ 3, & \text{otherwise,} \end{cases} \end{aligned}$$

and for  $i = n + 1$ ,

$$\begin{aligned} \mathcal{G}(((C_4)_{2,n}^{\leq})_{v_{n+1,1}}) &= \mathcal{G}(((C_4)_{2,n}^{\leq})_{v_{n+1,3}}) = \mathcal{G}((C_4)_{2,n-1}^{\leq}) \oplus 1 \\ &= \begin{cases} 2 \oplus 1, & \text{if } n \text{ is odd;} \\ 0 \oplus 1, & \text{otherwise} \end{cases} \\ &= \begin{cases} 3, & \text{if } n \text{ is odd;} \\ 1, & \text{otherwise.} \end{cases} \end{aligned}$$

Therefore,

$$\mathcal{G}((C_4)_{2,n}^{\leq}) = \begin{cases} \text{mex}\{2, 1, 1, 3\}, & \text{if } n \text{ is odd;} \\ \text{mex}\{0, 3, 3, 1\}, & \text{otherwise} \end{cases} = \begin{cases} 0, & \text{if } n \text{ is odd;} \\ 2, & \text{otherwise.} \end{cases}$$

To find  $\mathcal{G}(>(C_4)_{2,n}^{\leq})$ , we exhaust all possible first moves in the Node-Kayles game on  $>(C_4)_{2,n}^{\leq}$ . For each  $1 \leq i \leq n + 1$ ,

$$\begin{aligned} \mathcal{G}(>(C_4)_{2,n}^{\leq})_{v_{i,0}} &= \mathcal{G}((C_4)_{2,i-2}^{\leq}) \oplus \mathcal{G}((C_4)_{2,n-i}^{\leq}) \\ &= \begin{cases} 0 \oplus 2 \text{ or } 2 \oplus 0, & \text{if } n \text{ is odd;} \\ 0 \oplus 0 \text{ or } 2 \oplus 2, & \text{otherwise} \end{cases} \\ &= \begin{cases} 2, & \text{if } n \text{ is odd;} \\ 0, & \text{otherwise,} \end{cases} \end{aligned}$$

for  $1 \leq i \leq n$ ,

$$\begin{aligned} \mathcal{G}(\langle (C_4)_{2,n}^{\leq} \rangle_{v_{i,1}}) &= \mathcal{G}(\langle (C_4)_{2,n}^{\leq} \rangle_{v_{i,3}}) = \mathcal{G}(\langle (C_4)_{2,i-2}^{\leq} \rangle \oplus 1 \oplus \mathcal{G}(\langle (C_4)_{2,n-i-1}^{\leq} \rangle)) \\ &= \begin{cases} 0 \oplus 1 \oplus 0 \text{ or } 2 \oplus 1 \oplus 2, & \text{if } n \text{ is odd;} \\ 0 \oplus 1 \oplus 2 \text{ or } 2 \oplus 1 \oplus 0, & \text{otherwise} \end{cases} \\ &= \begin{cases} 1, & \text{if } n \text{ is odd;} \\ 3, & \text{otherwise,} \end{cases} \end{aligned}$$

and for  $i = 0$  or  $n + 1$ ,

$$\begin{aligned} \mathcal{G}(\langle (C_4)_{2,n}^{\leq} \rangle_{v_{i,1}}) &= \mathcal{G}(\langle (C_4)_{2,n}^{\leq} \rangle_{v_{i,3}}) = \mathcal{G}(\langle (C_4)_{2,n-1}^{\leq} \rangle \oplus 1) \\ &= \begin{cases} 2 \oplus 1, & \text{if } n \text{ is odd;} \\ 0 \oplus 1, & \text{otherwise} \end{cases} \\ &= \begin{cases} 3, & \text{if } n \text{ is odd;} \\ 1, & \text{otherwise.} \end{cases} \end{aligned}$$

Therefore,

$$\mathcal{G}(\langle (C_4)_{2,n}^{\leq} \rangle) = \begin{cases} \text{mex}\{2, 1, 3\}, & \text{if } n \text{ is odd;} \\ \text{mex}\{0, 3, 1\}, & \text{otherwise} \end{cases} = \begin{cases} 0, & \text{if } n \text{ is odd;} \\ 2, & \text{otherwise.} \end{cases}$$

□

To determine the Nimber sequence  $(\mathcal{G}((C_5)_{2,n}) : n \in \mathbb{N})$ , we need to further define five related families of graphs. The first variation, denoted by  $(C_5)_{2,n}^-$ , is a  $(2, n)$ -linked 5-cycle with an additional vertex  $v_{n+1,1}$  and an additional edge  $v_{n,2}v_{n+1,1}$ ; the second variation, denoted by  $(C_5)_{2,n}^{\square}$ , is the first variation  $(C_5)_{2,n}^-$  with additional vertices  $v_{n+1,3}$  and  $v_{n+1,4}$  and an additional path  $v_{n,2}v_{n+1,4}v_{n+1,3}$ ; the third variation, denoted by  $^-(C_5)_{2,n}^-$ , is the first variation  $(C_5)_{2,n}^-$  with an additional vertex  $v_{0,1}$  and an additional edge  $v_{0,1}v_{1,0}$ ; the fourth variation, denoted by  $^-(C_5)_{2,n}^{\square}$ , is the second variation  $(C_5)_{2,n}^{\square}$  with an additional vertex  $v_{0,1}$  and an additional edge  $v_{0,1}v_{1,0}$ ; the fifth variation, denoted by  $^{\square}(C_5)_{2,n}^{\square}$ , is the fourth variation  $^-(C_5)_{2,n}^{\square}$  with additional vertices  $v_{0,3}$  and  $v_{0,4}$  and an additional path  $v_{0,4}v_{0,3}v_{1,0}$ . Figures 17 to 22 are examples of a  $(2, n)$ -linked 5-cycle and its first to fifth variations, respectively.

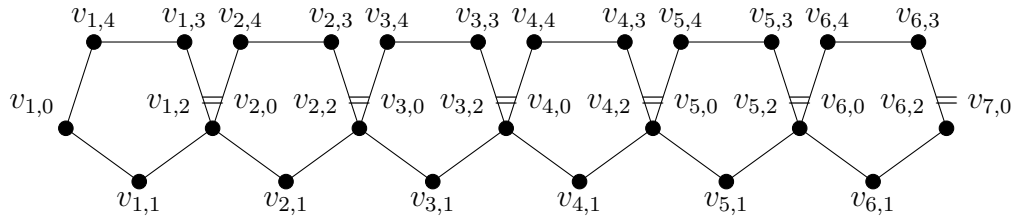

Figure 17: The  $(2, 6)$ -linked 5-cycle  $(C_5)_{2,6}$

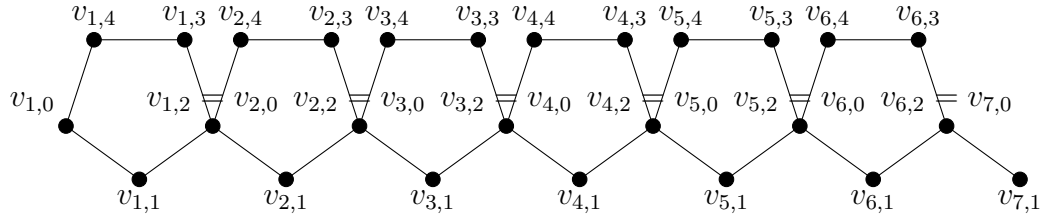

Figure 18: The first variation of the  $(2,6)$ -linked 5-cycle  $(C_5)_{2,6}^-$

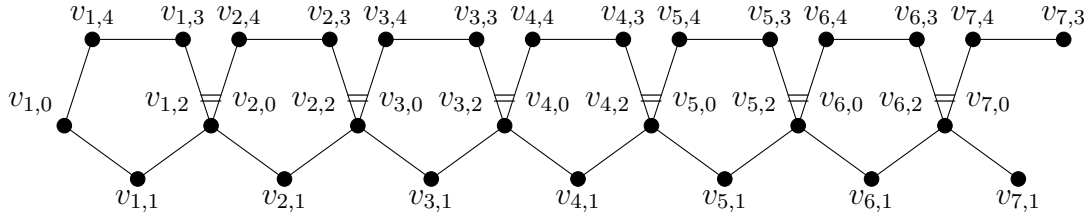

Figure 19: The second variation of the  $(2,6)$ -linked 5-cycle  $(C_5)_{2,6}^\square$

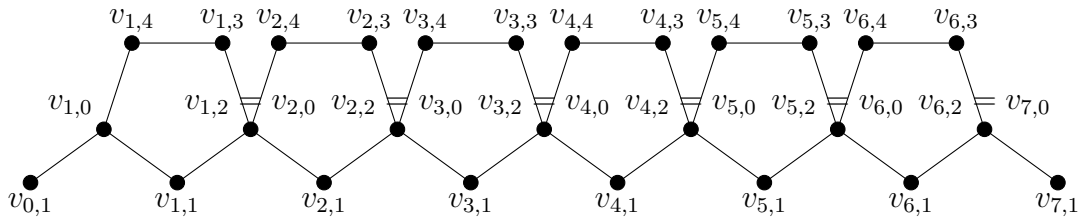

Figure 20: The third variation of the  $(2,6)$ -linked 5-cycle  $^-(C_5)_{2,6}^-$

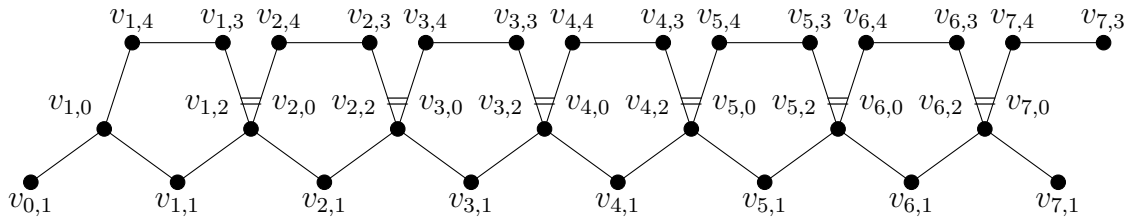

Figure 21: The fourth variation of the  $(2,6)$ -linked 5-cycle  $^-(C_5)_{2,6}^\square$

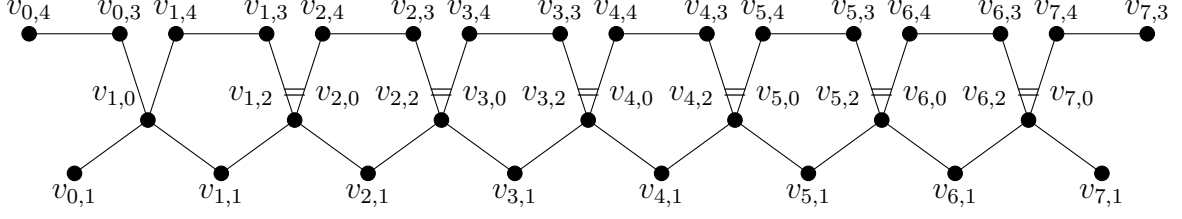

Figure 22: The fifth variation of the  $(2,6)$ -linked 5-cycle  $\sqsupset(C_5)_{2,6}^{\square}$

**Theorem 8.** *The Nimber sequences  $(\mathcal{G}((C_5)_{2,n}) : n \in \mathbb{N})$ ,  $(\mathcal{G}((C_5)_{2,n}^-) : n \in \mathbb{N})$ ,  $(\mathcal{G}((C_5)_{2,n}^{\square}) : n \in \mathbb{N})$ ,  $(\mathcal{G}(-(C_5)_{2,n}^-) : n \in \mathbb{N})$ ,  $(\mathcal{G}(-(C_5)_{2,n}^{\square}) : n \in \mathbb{N})$ , and  $(\mathcal{G}(\sqsupset(C_5)_{2,n}^{\square}) : n \in \mathbb{N})$  are given by the following:*

$$\mathcal{G}((C_5)_{2,n}) = \mathcal{G}(-(C_5)_{2,n}^-) = \mathcal{G}(\sqsupset(C_5)_{2,n}^{\square}) = \begin{cases} 0, & \text{if } n \text{ is odd;} \\ 2, & \text{otherwise,} \end{cases}$$

$$\mathcal{G}((C_5)_{2,n}^-) = \begin{cases} 3, & \text{if } n \text{ is odd;} \\ 1, & \text{otherwise,} \end{cases} \quad \mathcal{G}((C_5)_{2,n}^{\square}) = \begin{cases} 2, & \text{if } n \text{ is odd;} \\ 0, & \text{otherwise,} \end{cases}$$

$$\text{and } \mathcal{G}(-(C_5)_{2,n}^{\square}) = \begin{cases} 1, & \text{if } n \text{ is odd;} \\ 3, & \text{otherwise.} \end{cases}$$

*Proof.* First, we are going to prove the base cases for our strong induction.

$$\mathcal{G}((C_5)_{2,1}) = \mathcal{G}(\text{pentagon}) = \text{mex}\{\mathcal{G}(\text{path of 2 vertices})\} = \text{mex}\{\mathcal{G}(P_2)\} = \text{mex}\{1\} = 0.$$

$$\begin{aligned} \mathcal{G}((C_5)_{2,1}^-) &= \mathcal{G}(\text{pentagon with one vertex connected to two external vertices}) = \text{mex}\{\mathcal{G}(\text{path of 3 vertices}), \mathcal{G}(\text{path of 2 vertices}), \mathcal{G}(\text{path of 2 vertices}), \mathcal{G}(\text{pentagon})\} \\ &= \text{mex}\{\mathcal{G}(P_3), \mathcal{G}(P_2) \oplus 1, \mathcal{G}(P_2), \mathcal{G}(P_4)\} \\ &= \text{mex}\{2, 1 \oplus 1, 1, 0\} = 3. \end{aligned}$$

$$\begin{aligned} \mathcal{G}((C_5)_{2,1}^{\square}) &= \mathcal{G}(\text{pentagon with one vertex connected to two external vertices}) \\ &= \text{mex}\{\mathcal{G}(\text{pentagon}), \mathcal{G}(\text{path of 2 vertices}), \mathcal{G}(\text{path of 2 vertices}), \mathcal{G}(\text{path of 2 vertices}), \mathcal{G}(\text{path of 2 vertices}), \mathcal{G}(\text{pentagon})\} \\ &= \text{mex}\{\text{mex}\{\mathcal{G}(\text{path of 2 vertices}), \mathcal{G}(\text{path of 2 vertices}), \mathcal{G}(\text{path of 2 vertices}), \mathcal{G}(\text{path of 2 vertices})\}, \mathcal{G}(P_2) \oplus \mathcal{G}(P_2) \oplus 1, \\ &\quad \mathcal{G}(P_2) \oplus 1, \mathcal{G}(P_4) \oplus \mathcal{G}(P_2), \mathcal{G}(P_4) \oplus 1, \mathcal{G}((C_5)_{2,1}^-)\} \\ &= \text{mex}\{\text{mex}\{0, 1, 0, 2\}, 1 \oplus 1 \oplus 1, 1 \oplus 1, 0 \oplus 1, 0 \oplus 1, 3\} = 2. \end{aligned}$$

$$\begin{aligned}
\mathcal{G}({}^{-}(C_5)_{2,1}^-) &= \mathcal{G}(\text{graph}) = \text{mex}\{\mathcal{G}(\text{graph}), \mathcal{G}(\text{graph}), \mathcal{G}(\text{graph}), \mathcal{G}(\text{graph})\} \\
&= \text{mex}\{3, \mathcal{G}(P_3), 1 \oplus \mathcal{G}(P_2) \oplus 1, 1 \oplus \mathcal{G}(P_3)\} \\
&= \text{mex}\{3, 2, 1 \oplus 1 \oplus 1, 1 \oplus 2\} = 0.
\end{aligned}$$



$$\begin{aligned}
\mathcal{G}({}^{\square}(C_5)_{2,1}^{\square}) &= \mathcal{G}(\text{graph}) \\
&= \text{mex}\{\mathcal{G}(\text{graph}), \mathcal{G}(\text{graph}), \mathcal{G}(\text{graph}), \mathcal{G}(\text{graph}), \mathcal{G}(\text{graph}), \\
&\quad \mathcal{G}(\text{graph}), \mathcal{G}(\text{graph}), \mathcal{G}(\text{graph}), \mathcal{G}(\text{graph}), \mathcal{G}(\text{graph})\} \\
&= \text{mex}\{\text{mex}\{\mathcal{G}(\text{graph}), \mathcal{G}(\text{graph}), \mathcal{G}(\text{graph}), \mathcal{G}(\text{graph})\}, 3, \\
&\quad 1 \oplus \mathcal{G}(P_2) \oplus \mathcal{G}(P_2) \oplus 1, \mathcal{G}(P_3) \oplus 1, \mathcal{G}(P_3) \oplus \mathcal{G}(P_2) \oplus 1, 1 \oplus 3, 3 \oplus \mathcal{G}(P_2), \\
&\quad 3 \oplus 1, \mathcal{G}({}^{-}(C_5)_{2,1}^-)\} \\
&= \text{mex}\{\text{mex}\{1, 0, 1, 3\}, 3, 1 \oplus 1 \oplus 1 \oplus 1, 2 \oplus 1, 2 \oplus 1 \oplus 1, 2, 3 \oplus 1, 2, 0\} = 1.
\end{aligned}$$

$$\begin{aligned}
\mathcal{G}({}^{\square}(C_5)_{2,1}^{\square}) &= \mathcal{G}(\text{graph}) \\
&= \text{mex}\{\mathcal{G}(\text{graph}), \mathcal{G}(\text{graph}), \mathcal{G}(\text{graph}), \mathcal{G}(\text{graph}), \mathcal{G}(\text{graph}), \\
&\quad \mathcal{G}(\text{graph})\} \\
&= \text{mex}\{\mathcal{G}(P_2) \oplus 2, 1 \oplus 3, 1 \oplus 2, \mathcal{G}({}^{\square}(C_5)_{2,1}^{\square}), 1 \oplus \mathcal{G}(P_2) \oplus \mathcal{G}(P_2) \oplus \mathcal{G}(P_2) \oplus 1, \\
&\quad 1 \oplus \mathcal{G}(P_2) \oplus 3\} \\
&= \text{mex}\{3, 2, 3, 1, 1, 3\} = 0.
\end{aligned}$$

Before we proceed with our induction proof, it is convenient to extend the definitions of  $(C_5)_{2,n}^-$ ,  $(C_5)_{2,n}^{\square}$ , and  ${}^{-}(C_5)_{2,n}^-$  to the case when  $n = 0$ , as well as the definitions of  ${}^{-}(C_5)_{2,n}^{\square}$  and  ${}^{\square}(C_5)_{2,n}^{\square}$  to the cases when  $-1 \leq n \leq 0$  and determine the corresponding Nimbers as follows.

$n$	$(C_5)_{2,n}^-$	$\mathcal{G}((C_5)_{2,n}^-)$	$(C_5)_{2,n}^{\square}$	$\mathcal{G}((C_5)_{2,n}^{\square})$	${}^{-}(C_5)_{2,n}^-$	$\mathcal{G}({}^{-}(C_5)_{2,n}^-)$
0		1		0		2

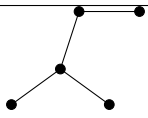
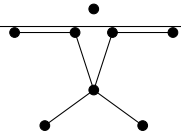

$n$	$-(C_5)_{2,n}^{\square}$	$\mathcal{G}(-(C_5)_{2,n}^{\square})$	$\sqsupset(C_5)_{2,n}^{\square}$	$\mathcal{G}(\sqsupset(C_5)_{2,n}^{\square})$
-1		1		0
0		3		2

Now, we are ready to finish our proof by strong induction. Assume that for some integer  $n \geq 2$ ,

$$\mathcal{G}((C_5)_{2,i}) = \begin{cases} 0, & \text{if } i \text{ is odd;} \\ 2, & \text{otherwise} \end{cases}$$

for all integers  $1 \leq i < n$ ,

$$\mathcal{G}((C_5)_{2,i}^-) = \begin{cases} 3, & \text{if } i \text{ is odd;} \\ 1, & \text{otherwise,} \end{cases} \quad \mathcal{G}((C_5)_{2,i}^{\square}) = \begin{cases} 2, & \text{if } i \text{ is odd;} \\ 0, & \text{otherwise,} \end{cases}$$

$$\text{and } \mathcal{G}(-(C_5)_{2,i}^-) = \begin{cases} 0, & \text{if } i \text{ is odd;} \\ 2, & \text{otherwise,} \end{cases}$$

for all integers  $0 \leq i < n$ , and

$$\mathcal{G}(-(C_5)_{2,i}^{\square}) = \begin{cases} 1, & \text{if } i \text{ is odd;} \\ 3, & \text{otherwise} \end{cases} \quad \text{and} \quad \mathcal{G}(\sqsupset(C_5)_{2,i}^{\square}) = \begin{cases} 0, & \text{if } i \text{ is odd;} \\ 2, & \text{otherwise} \end{cases}$$

for all integers  $-1 \leq i < n$ . To find  $\mathcal{G}((C_5)_{2,n})$ , we exhaust all possible first moves in the Node-Kayles game on  $(C_5)_{2,n}$ . For each  $2 \leq i \leq n$ ,

$$\begin{aligned} \mathcal{G}(((C_5)_{2,n})_{v_{i,0}}) &= \mathcal{G}((C_5)_{2,i-2}^-) \oplus \mathcal{G}((C_5)_{2,n-i}^-) \\ &= \begin{cases} 3 \oplus 1 \text{ or } 1 \oplus 3, & \text{if } n \text{ is odd;} \\ 3 \oplus 3 \text{ or } 1 \oplus 1, & \text{otherwise} \end{cases} \\ &= \begin{cases} 2, & \text{if } n \text{ is odd;} \\ 0, & \text{otherwise,} \end{cases} \end{aligned}$$

for  $2 \leq i \leq n-1$ ,

$$\begin{aligned} \mathcal{G}(((C_5)_{2,n})_{v_{i,1}}) &= \mathcal{G}((C_5)_{2,i-2}^{\square}) \oplus \mathcal{G}(P_2) \oplus \mathcal{G}((C_5)_{2,n-i-1}^{\square}) \\ &= \begin{cases} 2 \oplus 1 \oplus 2 \text{ or } 0 \oplus 1 \oplus 0, & \text{if } n \text{ is odd;} \\ 2 \oplus 1 \oplus 0 \text{ or } 0 \oplus 1 \oplus 2, & \text{otherwise} \end{cases} \\ &= \begin{cases} 1, & \text{if } n \text{ is odd;} \\ 3, & \text{otherwise} \end{cases} \end{aligned}$$

and

$$\begin{aligned}
\mathcal{G}(((C_5)_{2,n})_{v_{i,3}}) &= \mathcal{G}(((C_5)_{2,n})_{v_{n-i+1,4}}) = \mathcal{G}((C_5)_{2,i-1}^-) \oplus \mathcal{G}((C_5)_{2,n-i-1}^{\square}) \\
&= \begin{cases} 3 \oplus 0 \text{ or } 1 \oplus 2, & \text{if } n \text{ is odd;} \\ 3 \oplus 2 \text{ or } 1 \oplus 0, & \text{otherwise} \end{cases} \\
&= \begin{cases} 3, & \text{if } n \text{ is odd;} \\ 1, & \text{otherwise,} \end{cases}
\end{aligned}$$

and for  $i = 1$  or  $n$ ,

$$\begin{aligned}
\mathcal{G}(((C_5)_{2,n})_{v_{1,0}}) &= \mathcal{G}(((C_5)_{2,n})_{v_{1,4}}) = \mathcal{G}(((C_5)_{2,n})_{v_{n,2}}) = \mathcal{G}(((C_5)_{2,n})_{v_{n,3}}) \\
&= \mathcal{G}((C_5)_{2,n-1}^-) \\
&= \begin{cases} 1, & \text{if } n \text{ is odd;} \\ 3, & \text{otherwise} \end{cases}
\end{aligned}$$

and

$$\begin{aligned}
\mathcal{G}(((C_5)_{2,n})_{v_{1,1}}) &= \mathcal{G}(((C_5)_{2,n})_{v_{1,3}}) = \mathcal{G}(((C_5)_{2,n})_{v_{n,1}}) = \mathcal{G}(((C_5)_{2,n})_{v_{n,4}}) \\
&= \mathcal{G}(P_2) \oplus \mathcal{G}((C_5)_{2,n-2}^{\square}) \\
&= \begin{cases} 1 \oplus 2, & \text{if } n \text{ is odd;} \\ 1 \oplus 0, & \text{otherwise} \end{cases} \\
&= \begin{cases} 3, & \text{if } n \text{ is odd;} \\ 1, & \text{otherwise.} \end{cases}
\end{aligned}$$

Therefore,

$$\mathcal{G}((C_5)_{2,n}) = \begin{cases} \text{mex}\{2, 1, 3, 1, 3\}, & \text{if } n \text{ is odd;} \\ \text{mex}\{0, 3, 1, 3, 1\}, & \text{otherwise} \end{cases} = \begin{cases} 0, & \text{if } n \text{ is odd;} \\ 2, & \text{otherwise.} \end{cases}$$

To find  $\mathcal{G}((C_5)_{2,n}^-)$ , we exhaust all possible first moves in the Node-Kayles game on  $(C_5)_{2,n}^-$ . For each  $2 \leq i \leq n$ ,

$$\begin{aligned}
\mathcal{G}(((C_5)_{2,n}^-)_{v_{i,0}}) &= \mathcal{G}((C_5)_{2,i-2}^-) \oplus \mathcal{G}(-(C_5)_{2,n-i}^-) \\
&= \begin{cases} 3 \oplus 2 \text{ or } 1 \oplus 0, & \text{if } n \text{ is odd;} \\ 3 \oplus 0 \text{ or } 1 \oplus 2, & \text{otherwise} \end{cases} \\
&= \begin{cases} 1, & \text{if } n \text{ is odd;} \\ 3, & \text{otherwise,} \end{cases}
\end{aligned}$$

$$\begin{aligned}
\mathcal{G}(((C_5)_{2,n}^-)_{v_{i,1}}) &= \mathcal{G}((C_5)_{2,i-2}^{\square}) \oplus \mathcal{G}(P_2) \oplus \mathcal{G}(-(C_5)_{2,n-i-1}^{\square}) \\
&= \begin{cases} 2 \oplus 1 \oplus 1 \text{ or } 0 \oplus 1 \oplus 3, & \text{if } n \text{ is odd;} \\ 2 \oplus 1 \oplus 3 \text{ or } 0 \oplus 1 \oplus 1, & \text{otherwise} \end{cases} \\
&= \begin{cases} 2, & \text{if } n \text{ is odd;} \\ 0, & \text{otherwise,} \end{cases}
\end{aligned}$$

$$\begin{aligned}
\mathcal{G}(((C_5)_{2,n}^-)_{v_{i,3}}) &= \mathcal{G}((C_5)_{2,i-1}^-) \oplus \mathcal{G}(-(C_5)_{2,n-i-1}^{\square}) \\
&= \begin{cases} 3 \oplus 3 \text{ or } 1 \oplus 1, & \text{if } n \text{ is odd;} \\ 3 \oplus 1 \text{ or } 1 \oplus 3, & \text{otherwise} \end{cases} \\
&= \begin{cases} 0, & \text{if } n \text{ is odd;} \\ 2, & \text{otherwise,} \end{cases}
\end{aligned}$$

and

$$\begin{aligned}
\mathcal{G}(((C_5)_{2,n}^-)_{v_{i,4}}) &= \mathcal{G}((C_5)_{2,i-2}^{\square}) \oplus \mathcal{G}(-(C_5)_{2,n-i}^-) \\
&= \begin{cases} 2 \oplus 2 \text{ or } 0 \oplus 0, & \text{if } n \text{ is odd;} \\ 2 \oplus 0 \text{ or } 0 \oplus 2, & \text{otherwise} \end{cases} \\
&= \begin{cases} 0, & \text{if } n \text{ is odd;} \\ 2, & \text{otherwise,} \end{cases}
\end{aligned}$$

for  $i = 1$ ,

$$\mathcal{G}(((C_5)_{2,n}^-)_{v_{1,0}}) = \mathcal{G}(((C_5)_{2,n}^-)_{v_{1,4}}) = \mathcal{G}(-(C_5)_{2,n-1}^-) = \begin{cases} 2, & \text{if } n \text{ is odd;} \\ 0, & \text{otherwise} \end{cases}$$

and

$$\begin{aligned}
\mathcal{G}(((C_5)_{2,n}^-)_{v_{1,1}}) &= \mathcal{G}(((C_5)_{2,n}^-)_{v_{1,3}}) = \mathcal{G}(P_2) \oplus \mathcal{G}(-(C_5)_{2,n-2}^{\square}) \\
&= \begin{cases} 1 \oplus 1, & \text{if } n \text{ is odd;} \\ 1 \oplus 3, & \text{otherwise} \end{cases} \\
&= \begin{cases} 0, & \text{if } n \text{ is odd;} \\ 2, & \text{otherwise,} \end{cases}
\end{aligned}$$

and for  $i = n + 1$ ,

$$\mathcal{G}(((C_5)_{2,n}^-)_{v_{n+1,0}}) = \mathcal{G}((C_5)_{2,n-1}^-) = \begin{cases} 1, & \text{if } n \text{ is odd;} \\ 3, & \text{otherwise} \end{cases}$$

and

$$\mathcal{G}(((C_5)_{2,n}^-)_{v_{n+1,1}}) = \mathcal{G}((C_5)_{2,n-1}^{\square}) = \begin{cases} 0, & \text{if } n \text{ is odd;} \\ 2, & \text{otherwise.} \end{cases}$$

Therefore,

$$\mathcal{G}((C_5)_{2,n}^-) = \begin{cases} \text{mex}\{1, 2, 0, 0, 2, 0, 1, 0\}, & \text{if } n \text{ is odd;} \\ \text{mex}\{3, 0, 2, 2, 0, 2, 3, 2\}, & \text{otherwise} \end{cases} = \begin{cases} 3, & \text{if } n \text{ is odd;} \\ 1, & \text{otherwise.} \end{cases}$$

To find  $\mathcal{G}((C_5)_{2,n}^{\square})$ , we exhaust all possible first moves in the Node-Kayles game on  $(C_5)_{2,n}^{\square}$ . For each  $2 \leq i \leq n+1$ ,

$$\begin{aligned} \mathcal{G}(((C_5)_{2,n}^{\square})_{v_{i,0}}) &= \mathcal{G}((C_5)_{2,i-2}^-) \oplus \mathcal{G}(-(C_5)_{2,n-i}^{\square}) \\ &= \begin{cases} 3 \oplus 3 \text{ or } 1 \oplus 1, & \text{if } n \text{ is odd;} \\ 3 \oplus 1 \text{ or } 1 \oplus 3, & \text{otherwise} \end{cases} \\ &= \begin{cases} 0, & \text{if } n \text{ is odd;} \\ 2, & \text{otherwise,} \end{cases} \end{aligned}$$

for  $2 \leq i \leq n$ ,

$$\begin{aligned} \mathcal{G}(((C_5)_{2,n}^{\square})_{v_{i,1}}) &= \mathcal{G}((C_5)_{2,i-2}^{\square}) \oplus \mathcal{G}(P_2) \oplus \mathcal{G}(\square(C_5)_{2,n-i-1}^{\square}) \\ &= \begin{cases} 2 \oplus 1 \oplus 0 \text{ or } 0 \oplus 1 \oplus 2, & \text{if } n \text{ is odd;} \\ 2 \oplus 1 \oplus 2 \text{ or } 0 \oplus 1 \oplus 0, & \text{otherwise} \end{cases} \\ &= \begin{cases} 3, & \text{if } n \text{ is odd;} \\ 1, & \text{otherwise,} \end{cases} \end{aligned}$$

$$\begin{aligned} \mathcal{G}(((C_5)_{2,n}^{\square})_{v_{i,3}}) &= \mathcal{G}((C_5)_{2,i-1}^-) \oplus \mathcal{G}(\square(C_5)_{2,n-i-1}^{\square}) \\ &= \begin{cases} 3 \oplus 2 \text{ or } 1 \oplus 0, & \text{if } n \text{ is odd;} \\ 3 \oplus 0 \text{ or } 1 \oplus 2, & \text{otherwise} \end{cases} \\ &= \begin{cases} 1, & \text{if } n \text{ is odd;} \\ 3, & \text{otherwise,} \end{cases} \end{aligned}$$

and

$$\begin{aligned} \mathcal{G}(((C_5)_{2,n}^{\square})_{v_{i,4}}) &= \mathcal{G}((C_5)_{2,i-2}^{\square}) \oplus \mathcal{G}(-(C_5)_{2,n-i}^{\square}) \\ &= \begin{cases} 2 \oplus 3 \text{ or } 0 \oplus 1, & \text{if } n \text{ is odd;} \\ 2 \oplus 1 \text{ or } 0 \oplus 3, & \text{otherwise} \end{cases} \\ &= \begin{cases} 1, & \text{if } n \text{ is odd;} \\ 3, & \text{otherwise,} \end{cases} \end{aligned}$$

for  $i = 1$ ,

$$\mathcal{G}(((C_5)_{2,n}^{\square})_{v_{1,0}}) = \mathcal{G}(((C_5)_{2,n}^{\square})_{v_{1,4}}) = \mathcal{G}(-(C_5)_{2,n-1}^{\square}) = \begin{cases} 3, & \text{if } n \text{ is odd;} \\ 1, & \text{otherwise} \end{cases}$$

and

$$\begin{aligned} \mathcal{G}(((C_5)_{2,n}^{\square})_{v_{1,1}}) &= \mathcal{G}(((C_5)_{2,n}^{\square})_{v_{1,3}}) = \mathcal{G}(P_2) \oplus \mathcal{G}(\square(C_5)_{2,n-2}^{\square}) \\ &= \begin{cases} 1 \oplus 0, & \text{if } n \text{ is odd;} \\ 1 \oplus 2, & \text{otherwise} \end{cases} \\ &= \begin{cases} 1, & \text{if } n \text{ is odd;} \\ 3, & \text{otherwise,} \end{cases} \end{aligned}$$

and for  $i = n + 1$ ,

$$\begin{aligned} \mathcal{G}(((C_5)_{2,n}^{\square})_{v_{n+1,1}}) &= \mathcal{G}((C_5)_{2,n-1}^{\square}) \oplus \mathcal{G}(P_2) \\ &= \begin{cases} 0 \oplus 1, & \text{if } n \text{ is odd;} \\ 2 \oplus 1, & \text{otherwise} \end{cases} \\ &= \begin{cases} 1, & \text{if } n \text{ is odd;} \\ 3, & \text{otherwise,} \end{cases} \end{aligned}$$

$$\mathcal{G}(((C_5)_{2,n}^{\square})_{v_{n+1,3}}) = \mathcal{G}((C_5)_{2,n}^{\square}) = \begin{cases} 3, & \text{if } n \text{ is odd;} \\ 1, & \text{otherwise,} \end{cases}$$

and

$$\begin{aligned} \mathcal{G}(((C_5)_{2,n}^{\square})_{v_{n+1,4}}) &= \mathcal{G}((C_5)_{2,n-1}^{\square}) \oplus 1 \\ &= \begin{cases} 0 \oplus 1, & \text{if } n \text{ is odd;} \\ 2 \oplus 1, & \text{otherwise} \end{cases} \\ &= \begin{cases} 1, & \text{if } n \text{ is odd;} \\ 3, & \text{otherwise.} \end{cases} \end{aligned}$$

Therefore,

$$\mathcal{G}((C_5)_{2,n}^{\square}) = \begin{cases} \text{mex}\{0, 3, 1, 1, 3, 1, 1, 3, 1\}, & \text{if } n \text{ is odd;} \\ \text{mex}\{2, 1, 3, 3, 1, 3, 3, 1, 3\}, & \text{otherwise} \end{cases} = \begin{cases} 2, & \text{if } n \text{ is odd;} \\ 0, & \text{otherwise.} \end{cases}$$

To find  $\mathcal{G}(- (C_5)_{2,n}^-)$ , we exhaust all possible first moves in the Node-Kayles game on  $- (C_5)_{2,n}^-$ . For each  $2 \leq i \leq n$ ,

$$\begin{aligned} \mathcal{G}((- (C_5)_{2,n}^-)_{v_{i,0}}) &= \mathcal{G}(- (C_5)_{2,i-2}^-) \oplus \mathcal{G}(- (C_5)_{2,n-i}^-) \\ &= \begin{cases} 0 \oplus 2 \text{ or } 2 \oplus 0, & \text{if } n \text{ is odd;} \\ 0 \oplus 0 \text{ or } 2 \oplus 2, & \text{otherwise} \end{cases} \\ &= \begin{cases} 2, & \text{if } n \text{ is odd;} \\ 0, & \text{otherwise,} \end{cases} \end{aligned}$$

for  $1 \leq i \leq n$ ,

$$\begin{aligned} \mathcal{G}((- (C_5)_{2,n}^-)_{v_{i,1}}) &= \mathcal{G}(- (C_5)_{2,i-2}^{\square}) \oplus \mathcal{G}(P_2) \oplus \mathcal{G}(- (C_5)_{2,n-i-1}^{\square}) \\ &= \begin{cases} 1 \oplus 1 \oplus 1 \text{ or } 3 \oplus 1 \oplus 3, & \text{if } n \text{ is odd;} \\ 1 \oplus 1 \oplus 3 \text{ or } 3 \oplus 1 \oplus 1, & \text{otherwise} \end{cases} \\ &= \begin{cases} 1, & \text{if } n \text{ is odd;} \\ 3, & \text{otherwise} \end{cases} \end{aligned}$$

and

$$\begin{aligned} \mathcal{G}((- (C_5)_{2,n}^-)_{v_{i,3}}) &= \mathcal{G}((- (C_5)_{2,n}^-)_{v_{n-i+1,4}}) = \mathcal{G}(- (C_5)_{2,i-1}^-) \oplus \mathcal{G}(- (C_5)_{2,n-i-1}^{\square}) \\ &= \begin{cases} 0 \oplus 3 \text{ or } 2 \oplus 1, & \text{if } n \text{ is odd;} \\ 0 \oplus 1 \text{ or } 2 \oplus 3, & \text{otherwise} \end{cases} \\ &= \begin{cases} 3, & \text{if } n \text{ is odd;} \\ 1, & \text{otherwise,} \end{cases} \end{aligned}$$

for  $i = 1$  or  $n + 1$ ,

$$\mathcal{G}((- (C_5)_{2,n}^-)_{v_{i,0}}) = \mathcal{G}(- (C_5)_{2,n-1}^-) = \begin{cases} 2, & \text{if } n \text{ is odd;} \\ 0, & \text{otherwise} \end{cases}$$

and for  $i = 0$  or  $n + 1$ ,

$$\mathcal{G}((- (C_5)_{2,n}^-)_{v_{i,1}}) = \mathcal{G}(- (C_5)_{2,n-1}^{\square}) = \begin{cases} 3, & \text{if } n \text{ is odd;} \\ 1, & \text{otherwise.} \end{cases}$$

Therefore,

$$\mathcal{G}(- (C_5)_{2,n}^-) = \begin{cases} \text{mex}\{2, 1, 3, 3, 2, 3\}, & \text{if } n \text{ is odd;} \\ \text{mex}\{0, 3, 1, 1, 0, 1\}, & \text{otherwise} \end{cases} = \begin{cases} 0, & \text{if } n \text{ is odd;} \\ 2, & \text{otherwise.} \end{cases}$$

To find  $\mathcal{G}(-(C_5)_{2,n}^{\square})$ , we exhaust all possible first moves in the Node-Kayles game on  $-(C_5)_{2,n}^{\square}$ . For each  $2 \leq i \leq n+1$ ,

$$\begin{aligned} \mathcal{G}(-(C_5)_{2,n}^{\square})_{v_{i,0}} &= \mathcal{G}(-(C_5)_{2,i-2}^{\square}) \oplus \mathcal{G}(-(C_5)_{2,n-i}^{\square}) \\ &= \begin{cases} 0 \oplus 3 \text{ or } 2 \oplus 1, & \text{if } n \text{ is odd;} \\ 0 \oplus 1 \text{ or } 2 \oplus 3, & \text{otherwise} \end{cases} \\ &= \begin{cases} 3, & \text{if } n \text{ is odd;} \\ 1, & \text{otherwise,} \end{cases} \end{aligned}$$

for  $1 \leq i \leq n$ ,

$$\begin{aligned} \mathcal{G}(-(C_5)_{2,n}^{\square})_{v_{i,1}} &= \mathcal{G}(-(C_5)_{2,i-2}^{\square}) \oplus \mathcal{G}(P_2) \oplus \mathcal{G}(\square(C_5)_{2,n-i-1}^{\square}) \\ &= \begin{cases} 1 \oplus 1 \oplus 0 \text{ or } 3 \oplus 1 \oplus 2, & \text{if } n \text{ is odd;} \\ 1 \oplus 1 \oplus 2 \text{ or } 3 \oplus 1 \oplus 0, & \text{otherwise} \end{cases} \\ &= \begin{cases} 0, & \text{if } n \text{ is odd;} \\ 2, & \text{otherwise,} \end{cases} \end{aligned}$$

$$\begin{aligned} \mathcal{G}(-(C_5)_{2,n}^{\square})_{v_{i,3}} &= \mathcal{G}(-(C_5)_{2,i-1}^{\square}) \oplus \mathcal{G}(\square(C_5)_{2,n-i-1}^{\square}) \\ &= \begin{cases} 0 \oplus 2 \text{ or } 2 \oplus 0, & \text{if } n \text{ is odd;} \\ 0 \oplus 0 \text{ or } 2 \oplus 2, & \text{otherwise} \end{cases} \\ &= \begin{cases} 2, & \text{if } n \text{ is odd;} \\ 0, & \text{otherwise,} \end{cases} \end{aligned}$$

and

$$\begin{aligned} \mathcal{G}(-(C_5)_{2,n}^{\square})_{v_{i,4}} &= \mathcal{G}(-(C_5)_{2,i-2}^{\square}) \oplus \mathcal{G}(-(C_5)_{2,n-i}^{\square}) \\ &= \begin{cases} 1 \oplus 3 \text{ or } 3 \oplus 1, & \text{if } n \text{ is odd;} \\ 1 \oplus 1 \text{ or } 3 \oplus 3, & \text{otherwise} \end{cases} \\ &= \begin{cases} 2, & \text{if } n \text{ is odd;} \\ 0, & \text{otherwise,} \end{cases} \end{aligned}$$

for  $i = 1$ ,

$$\mathcal{G}(-(C_5)_{2,n}^{\square})_{v_{1,0}} = \mathcal{G}(-(C_5)_{2,n-1}^{\square}) = \begin{cases} 3, & \text{if } n \text{ is odd;} \\ 1, & \text{otherwise,} \end{cases}$$

for  $i = 0$ ,

$$\mathcal{G}(-(C_5)_{2,n}^{\square})_{v_{0,1}} = \mathcal{G}(\square(C_5)_{2,n-1}^{\square}) = \begin{cases} 2, & \text{if } n \text{ is odd;} \\ 0, & \text{otherwise,} \end{cases}$$

and for  $i = n + 1$ ,

$$\begin{aligned}\mathcal{G}((- (C_5)_{2,n}^{\square})_{v_{n+1,1}}) &= \mathcal{G}(- (C_5)_{2,n-1}^{\square}) \oplus \mathcal{G}(P_2) \\ &= \begin{cases} 3 \oplus 1, & \text{if } n \text{ is odd;} \\ 1 \oplus 1, & \text{otherwise} \end{cases} \\ &= \begin{cases} 2, & \text{if } n \text{ is odd;} \\ 0, & \text{otherwise,} \end{cases}\end{aligned}$$

$$\mathcal{G}((- (C_5)_{2,n}^{\square})_{v_{n+1,3}}) = \mathcal{G}(- (C_5)_{2,n}^{\square}) = \begin{cases} 0, & \text{if } n \text{ is odd;} \\ 2, & \text{otherwise,} \end{cases}$$

and

$$\begin{aligned}\mathcal{G}((- (C_5)_{2,n}^{\square})_{v_{n+1,4}}) &= \mathcal{G}(- (C_5)_{2,n-1}^{\square}) \oplus 1 \\ &= \begin{cases} 3 \oplus 1, & \text{if } n \text{ is odd;} \\ 1 \oplus 1, & \text{otherwise} \end{cases} \\ &= \begin{cases} 2, & \text{if } n \text{ is odd;} \\ 0, & \text{otherwise.} \end{cases}\end{aligned}$$

Therefore,

$$\mathcal{G}(- (C_5)_{2,n}^{\square}) = \begin{cases} \text{mex}\{3, 0, 2, 2, 3, 2, 2, 0, 2\}, & \text{if } n \text{ is odd;} \\ \text{mex}\{1, 2, 0, 0, 1, 0, 0, 2, 0\}, & \text{otherwise} \end{cases} = \begin{cases} 1, & \text{if } n \text{ is odd;} \\ 3, & \text{otherwise.} \end{cases}$$

To find  $\mathcal{G}(\sqsupset (C_5)_{2,n}^{\square})$ , we exhaust all possible first moves in the Node-Kayles game on  $\sqsupset (C_5)_{2,n}^{\square}$ . For each  $1 \leq i \leq n + 1$ ,

$$\begin{aligned}\mathcal{G}(\sqsupset (C_5)_{2,n}^{\square})_{v_{i,0}} &= \mathcal{G}(- (C_5)_{2,i-2}^{\square}) \oplus \mathcal{G}(- (C_5)_{2,n-i}^{\square}) \\ &= \begin{cases} 1 \oplus 3 \text{ or } 3 \oplus 1, & \text{if } n \text{ is odd;} \\ 1 \oplus 1 \text{ or } 3 \oplus 3, & \text{otherwise} \end{cases} \\ &= \begin{cases} 2, & \text{if } n \text{ is odd;} \\ 0, & \text{otherwise,} \end{cases}\end{aligned}$$

for  $1 \leq i \leq n$ ,

$$\begin{aligned}\mathcal{G}(\sqsupset (C_5)_{2,n}^{\square})_{v_{i,1}} &= \mathcal{G}(\sqsupset (C_5)_{2,i-2}^{\square}) \oplus \mathcal{G}(P_2) \oplus \mathcal{G}(\sqsupset (C_5)_{2,n-i-1}^{\square}) \\ &= \begin{cases} 0 \oplus 1 \oplus 0 \text{ or } 2 \oplus 1 \oplus 2, & \text{if } n \text{ is odd;} \\ 0 \oplus 1 \oplus 2 \text{ or } 2 \oplus 1 \oplus 0, & \text{otherwise} \end{cases} \\ &= \begin{cases} 1, & \text{if } n \text{ is odd;} \\ 3, & \text{otherwise} \end{cases}\end{aligned}$$



and

$$\begin{aligned}
\mathcal{G}((\square(C_5)_{2,n}^{\square})_{v_{i,3}}) &= \mathcal{G}((\square(C_5)_{2,n}^{\square})_{v_{n-i+1,4}}) = \mathcal{G}({}^-(C_5)_{2,i-1}^{\square}) \oplus \mathcal{G}(\square(C_5)_{2,n-i-1}^{\square}) \\
&= \begin{cases} 1 \oplus 2 \text{ or } 3 \oplus 0, & \text{if } n \text{ is odd;} \\ 1 \oplus 0 \text{ or } 3 \oplus 2, & \text{otherwise} \end{cases} \\
&= \begin{cases} 3, & \text{if } n \text{ is odd;} \\ 1, & \text{otherwise,} \end{cases}
\end{aligned}$$

for  $i = 0$  or  $n + 1$ ,

$$\begin{aligned}
\mathcal{G}((\square(C_5)_{2,n}^{\square})_{v_{i,1}}) &= \mathcal{G}(P_2) \oplus \mathcal{G}(\square(C_5)_{2,n-1}^{\square}) \\
&= \begin{cases} 1 \oplus 2, & \text{if } n \text{ is odd;} \\ 1 \oplus 0, & \text{otherwise,} \end{cases} \\
&= \begin{cases} 3, & \text{if } n \text{ is odd;} \\ 1, & \text{otherwise,} \end{cases}
\end{aligned}$$

$$\begin{aligned}
\mathcal{G}((\square(C_5)_{2,n}^{\square})_{v_{0,3}}) &= \mathcal{G}((\square(C_5)_{2,n}^{\square})_{v_{n+1,4}}) = 1 \oplus \mathcal{G}(\square(C_5)_{2,n-1}^{\square}) \\
&= \begin{cases} 1 \oplus 2, & \text{if } n \text{ is odd;} \\ 1 \oplus 0, & \text{otherwise,} \end{cases} \\
&= \begin{cases} 3, & \text{if } n \text{ is odd;} \\ 1, & \text{otherwise,} \end{cases}
\end{aligned}$$

and

$$\mathcal{G}((\square(C_5)_{2,n}^{\square})_{v_{0,4}}) = \mathcal{G}((\square(C_5)_{2,n}^{\square})_{v_{n+1,3}}) = \mathcal{G}({}^-(C_5)_{2,n}^{\square}) = \begin{cases} 1, & \text{if } n \text{ is odd;} \\ 3, & \text{otherwise.} \end{cases}$$

Therefore,

$$\mathcal{G}(\square(C_5)_{2,n}^{\square}) = \begin{cases} \text{mex}\{2, 1, 3, 3, 3, 1\}, & \text{if } n \text{ is odd;} \\ \text{mex}\{0, 3, 1, 1, 1, 3\}, & \text{otherwise} \end{cases} = \begin{cases} 0, & \text{if } n \text{ is odd;} \\ 2, & \text{otherwise.} \end{cases}$$

□

To study the Nimber sequence  $(\mathcal{G}((C_4)_{1,n}) : n \in \mathbb{N})$ , we need to further define two related families of graphs. The first variation, denoted by  $(C_4)_{1,n}^{\vee}$ , is a  $(1, n)$ -linked 4-cycle with additional vertices  $v_{n+1,2}$  and  $v_{n+1,3}$  and an additional path  $v_{n,1}v_{n+1,3}v_{n+1,2}$ ; the second variation, denoted by  ${}^{\vee}(C_4)_{1,n}$ , is the first variation  $(C_4)_{1,n}^{\vee}$  with additional vertices  $v_{0,2}$  and  $v_{0,3}$  and an additional path  $v_{1,0}v_{0,2}v_{0,3}$ . Figures 23 and 24 are examples of the first and second variations of a  $(1, n)$ -linked 4-cycle, respectively.

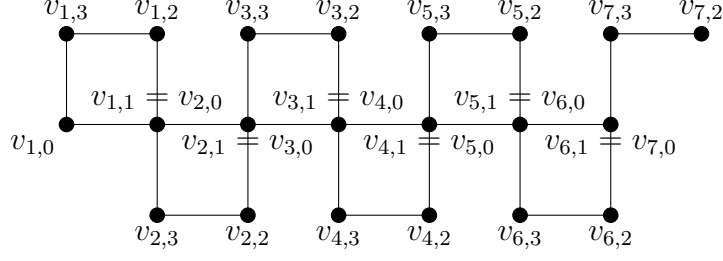

Figure 23: The first variation of the  $(1, 6)$ -linked 4-cycle  $(C_4)_{1,6}^{\vee}$

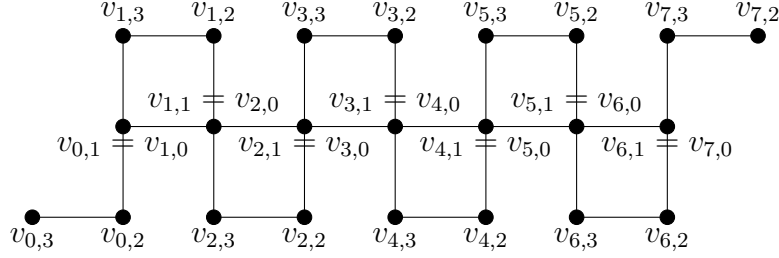

Figure 24: The second variation of the  $(1, 6)$ -linked 4-cycle  ${}^{\vee}(C_4)_{1,6}^{\vee}$

It is also convenient to extend the definition of  $(C_4)_{1,n}$  to the case when  $n = 0$ , the definition of  $(C_4)_{1,n}^{\vee}$  to the cases when  $-1 \leq n \leq 0$ , as well as the definition of  ${}^{\vee}(C_4)_{1,n}^{\vee}$  to the cases when  $-2 \leq n \leq 0$  and determine the corresponding Nimbers as follows.

$n$	$(C_4)_{1,n}$	$\mathcal{G}((C_4)_{1,n})$	$(C_4)_{1,n}^{\vee}$	$\mathcal{G}((C_4)_{1,n}^{\vee})$	${}^{\vee}(C_4)_{1,n}^{\vee}$	$\mathcal{G}({}^{\vee}(C_4)_{1,n}^{\vee})$
-2	N/A	N/A	N/A	N/A	$\emptyset$	0
-1	N/A	N/A	$\emptyset$	0		1
0	$\bullet$	1		2		3

**Theorem 9.** *The Nimber sequences  $(\mathcal{G}((C_4)_{1,n}) : n \in \mathbb{N})$ ,  $(\mathcal{G}((C_4)_{1,n}^{\vee}) : n \in \mathbb{N})$ , and  $(\mathcal{G}({}^{\vee}(C_4)_{1,n}^{\vee}) : n \in \mathbb{N})$  satisfy recursions*

$$\mathcal{G}((C_4)_{1,n}) = \text{mex} \left( \{ \mathcal{G}((C_4)_{1,i-3}^{\vee}) \oplus \mathcal{G}((C_4)_{1,n-i-1}^{\vee}) : 2 \leq i \leq n \} \cup \{ \mathcal{G}((C_4)_{1,i-1}) \oplus \mathcal{G}((C_4)_{1,n-i-1}^{\vee}) : 1 \leq i \leq n \} \right),$$

$$\mathcal{G}((C_4)_{1,n}^{\vee}) = \text{mex} \left( \{ \mathcal{G}((C_4)_{1,i-3}^{\vee}) \oplus \mathcal{G}({}^{\vee}(C_4)_{1,n-i-1}^{\vee}) : 2 \leq i \leq n \} \cup \{ \mathcal{G}((C_4)_{1,i-1}) \oplus \mathcal{G}({}^{\vee}(C_4)_{1,n-i-1}^{\vee}), \mathcal{G}((C_4)_{1,i-2}^{\vee}) \oplus \mathcal{G}((C_4)_{1,n-i}^{\vee}) : 1 \leq i \leq n \} \right),$$

and

$$\begin{aligned} \mathcal{G}(\vee(C_4)_{1,n}^\vee) &= \text{mex} \left( \{ \mathcal{G}(\vee(C_4)_{1,i-3}^\vee) \oplus \mathcal{G}(\vee(C_4)_{1,n-i-1}^\vee) : 1 \leq i \leq n+1 \} \right. \\ &\quad \left. \cup \{ \mathcal{G}((C_4)_{1,i-1}^\vee) \oplus \mathcal{G}(\vee(C_4)_{1,n-i-1}^\vee) : 0 \leq i \leq n+1 \} \right). \end{aligned}$$

*Proof.* For each positive integer  $n$ , to find  $\mathcal{G}((C_4)_{1,n})$ , we exhaust all possible first moves in the Node-Kayles game on  $(C_4)_{1,n}$ . For each  $2 \leq i \leq n$ ,

$$\mathcal{G}(((C_4)_{1,n})_{v_{i,0}}) = \mathcal{G}((C_4)_{1,i-3}^\vee) \oplus 1 \oplus 1 \oplus \mathcal{G}((C_4)_{1,n-i-1}^\vee) = \mathcal{G}((C_4)_{1,i-3}^\vee) \oplus \mathcal{G}((C_4)_{1,n-i-1}^\vee),$$

for  $1 \leq i \leq n$ ,

$$\mathcal{G}(((C_4)_{1,n})_{v_{i,2}}) = \mathcal{G}(((C_4)_{1,n})_{v_{n-i+1,3}}) = \mathcal{G}((C_4)_{1,i-1}) \oplus \mathcal{G}((C_4)_{1,n-i-1}^\vee),$$

and for  $i = 1$  or  $n$ ,

$$\mathcal{G}(((C_4)_{1,n})_{v_{1,0}}) = \mathcal{G}(((C_4)_{1,n})_{v_{n,1}}) = \mathcal{G}((C_4)_{1,0}) \oplus \mathcal{G}((C_4)_{1,n-2}^\vee).$$

Therefore,

$$\begin{aligned} \mathcal{G}((C_4)_{1,n}) &= \text{mex} \left( \{ \mathcal{G}((C_4)_{1,i-3}^\vee) \oplus \mathcal{G}((C_4)_{1,n-i-1}^\vee) : 2 \leq i \leq n \} \right. \\ &\quad \left. \cup \{ \mathcal{G}((C_4)_{1,i-1}) \oplus \mathcal{G}((C_4)_{1,n-i-1}^\vee) : 1 \leq i \leq n \} \right). \end{aligned}$$

To find  $\mathcal{G}((C_4)_{1,n}^\vee)$ , we exhaust all possible first moves in the Node-Kayles game on  $(C_4)_{1,n}^\vee$ . For each  $2 \leq i \leq n+1$ ,

$$\mathcal{G}(((C_4)_{1,n}^\vee)_{v_{i,0}}) = \mathcal{G}((C_4)_{1,i-3}^\vee) \oplus 1 \oplus 1 \oplus \mathcal{G}(\vee(C_4)_{1,n-i-1}^\vee) = \mathcal{G}((C_4)_{1,i-3}^\vee) \oplus \mathcal{G}(\vee(C_4)_{1,n-i-1}^\vee),$$

for  $1 \leq i \leq n+1$ ,

$$\mathcal{G}(((C_4)_{1,n}^\vee)_{v_{i,2}}) = \mathcal{G}((C_4)_{1,i-1}) \oplus \mathcal{G}(\vee(C_4)_{1,n-i-1}^\vee)$$

and

$$\mathcal{G}(((C_4)_{1,n}^\vee)_{v_{i,3}}) = \mathcal{G}((C_4)_{1,i-2}^\vee) \oplus \mathcal{G}((C_4)_{1,n-i}^\vee),$$

and for  $i = 1$ ,

$$\mathcal{G}(((C_4)_{1,n}^\vee)_{v_{1,0}}) = \mathcal{G}((C_4)_{1,0}) \oplus \mathcal{G}(\vee(C_4)_{1,n-2}^\vee).$$

Therefore,

$$\begin{aligned} \mathcal{G}((C_4)_{1,n}^\vee) &= \text{mex} \left( \{ \mathcal{G}((C_4)_{1,i-3}^\vee) \oplus \mathcal{G}(\vee(C_4)_{1,n-i-1}^\vee) : 2 \leq i \leq n+1 \} \right. \\ &\quad \cup \{ \mathcal{G}((C_4)_{1,i-1}) \oplus \mathcal{G}(\vee(C_4)_{1,n-i-1}^\vee), \\ &\quad \left. \mathcal{G}((C_4)_{1,i-2}^\vee) \oplus \mathcal{G}((C_4)_{1,n-i}^\vee) : 1 \leq i \leq n+1 \} \right). \end{aligned}$$

Finally, to find  $\mathcal{G}(\vee(C_4)_{1,n}^\vee)$ , we exhaust all possible first moves in the Node-Kayles game on  $\vee(C_4)_{1,n}^\vee$ . For each  $1 \leq i \leq n+1$ ,

$$\begin{aligned}\mathcal{G}(\vee(C_4)_{1,n}^\vee)_{v_{i,0}} &= \mathcal{G}(\vee(C_4)_{1,i-3}^\vee) \oplus 1 \oplus 1 \oplus \mathcal{G}(\vee(C_4)_{1,n-i-1}^\vee) \\ &= \mathcal{G}(\vee(C_4)_{1,i-3}^\vee) \oplus \mathcal{G}(\vee(C_4)_{1,n-i-1}^\vee),\end{aligned}$$

and for  $0 \leq i \leq n+1$ ,

$$\mathcal{G}(\vee(C_4)_{1,n}^\vee)_{v_{i,2}} = \mathcal{G}(\vee(C_4)_{1,n}^\vee)_{v_{n-i+1,3}} = \mathcal{G}(\vee(C_4)_{1,i-1}^\vee) \oplus \mathcal{G}(\vee(C_4)_{1,n-i-1}^\vee).$$

Therefore,

$$\begin{aligned}\mathcal{G}(\vee(C_4)_{1,n}^\vee) &= \text{mex}(\{\mathcal{G}(\vee(C_4)_{1,i-3}^\vee) \oplus \mathcal{G}(\vee(C_4)_{1,n-i-1}^\vee) : 1 \leq i \leq n+1\} \\ &\quad \cup \{\mathcal{G}(\vee(C_4)_{1,i-1}^\vee) \oplus \mathcal{G}(\vee(C_4)_{1,n-i-1}^\vee) : 0 \leq i \leq n+1\}).\end{aligned}$$

□

With the recursions given by Theorem 9, we can easily compute the first 100,000 terms in the Nimber sequence  $(\mathcal{G}(\vee(C_4)_{1,n}) : n \in \mathbb{N})$ , which is now listed on the OEIS as [A316629](#) [7]. Note that sequence  $(\mathcal{G}(\vee(C_4)_{1,n}) : n \in \mathbb{N})$  does not seem to be periodic, nor are we able to find a closed form. It is mildly surprising that the Nimber sequences of the Node-Kayles game on linked 4-cycles differ so drastically by changing the link vertices.

We finish this section with our study on the Nimber sequence of linked diamonds. A *diamond* is formed by adding an additional diagonal edge to a 4-cycle, i.e., a diamond has vertex set  $\{v_0, v_1, v_2, v_3\}$  and edge set  $\{v_0v_1, v_1v_2, v_2v_3, v_3v_0, v_0v_2\}$ . To form an  $n$ -linked diamond  $D_n$ , we begin with a collection of  $n$  diamonds with vertex sets  $\{v_{i,0}, v_{i,1}, v_{i,2}, v_{i,3}\}$  for  $1 \leq i \leq n$ , and we identify vertices such that  $v_{i,2} = v_{i+1,0}$  for all  $1 \leq i \leq n-1$ . The vertex  $v_{n,2}$  will also be called  $v_{n+1,0}$ .

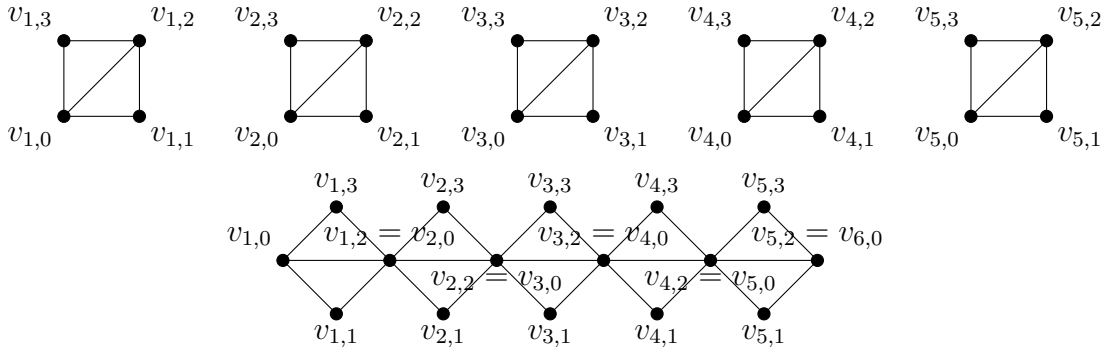

Figure 25: Linking 5 diamonds (top) as  $D_5$  (bottom)

If we try to link  $n$  diamonds after rotating each of them by 90 degrees, we will obtain a  $2n$ -chained clique that chains up  $2n$  copies of  $K_3$ , which was studied in Section 4. Hence, we do not consider the graph in Figure 26 as a linked diamond.

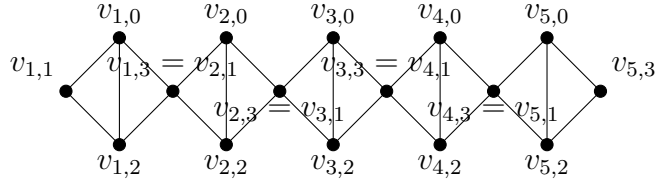

Figure 26: A  $2n$ -chained clique  $CK_{2n}$

To study the Nimber sequence  $(\mathcal{G}(D_n) : n \in \mathbb{N})$ , we need to further define two related families of graphs. The first variation, denoted by  $D_n^<$ , is an  $n$ -linked diamond with additional vertices  $v_{n+1,1}$  and  $v_{n+1,3}$  and additional edges  $v_{n,2}v_{n+1,1}$  and  $v_{n,2}v_{n+1,3}$ ; the second variation, denoted by  $>D_n^<$ , is the first variation  $D_n^<$  with additional vertices  $v_{0,1}$  and  $v_{0,3}$  and additional edges  $v_{0,1}v_{1,0}$  and  $v_{0,3}v_{1,0}$ . Figures 27 and 28 are examples of the first and second variations of an  $n$ -linked diamond, respectively.

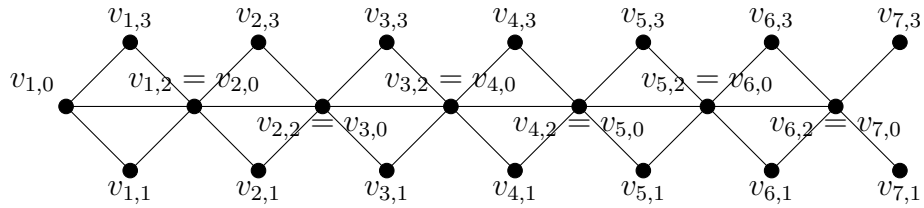

Figure 27: The first variation of the 6-linked diamond  $D_6^<$

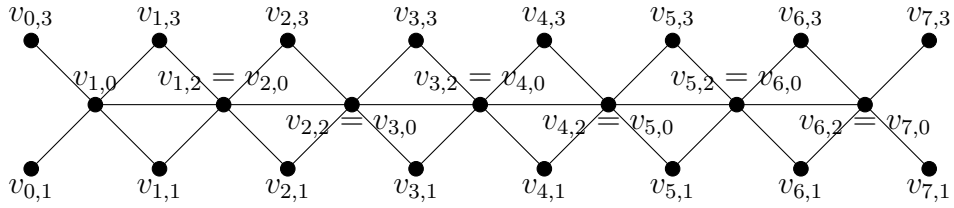
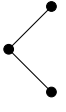
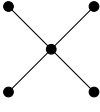

Figure 28: The second variation of the 6-linked diamond  $>D_6^<$

It is also convenient to extend the definitions of  $D_n^<$  and  $>D_n^<$  to the cases when  $-2 \leq n \leq 0$  and determine the corresponding Nimbers as follows.

$n$	$D_n^<$	$\mathcal{G}(D_n^<)$	$>D_n^<$	$\mathcal{G}(>D_n^<)$
-2	$\emptyset$	0	$\emptyset$	0
-1	$\emptyset$	0	•	0
0		2		2

To simplify the notation, we define  $a(n) = \mathcal{G}(D_n)$ ,  $b(n) = \mathcal{G}(D_n^<)$ , and  $c(n) = \mathcal{G}(>D_n^<)$ . The sequence  $(a(n) : n \in \mathbb{N})$  is now listed on the OEIS as [A316781](#) [7].

**Theorem 10.** *The Nimber sequences  $(a(n) : n \geq 69)$ ,  $(b(n) : n \geq 69)$ , and  $(c(n) : n \geq 69)$  are periodic with period 12.*

*Proof.* By the symmetry of  $>D_n^<$ , we have

$$c(n) = \text{mex} \left( \{ \mathcal{G}((>D_n^<)_{v_{i,0}}) : 1 \leq i \leq \lceil (n+1)/2 \rceil \} \cup \{ \mathcal{G}((>D_n^<)_{v_{i,1}}) : 0 \leq i \leq \lfloor (n+1)/2 \rfloor \} \right).$$

It is easy to see that

$$\mathcal{G}((>D_n^<)_{v_{i,0}}) = \mathcal{G}(^>D_{i-3}^<) \oplus \mathcal{G}(^>D_{n-i-1}^<)$$

and

$$\mathcal{G}((>D_n^<)_{v_{i,1}}) = \mathcal{G}(^>D_{i-2}^<) \oplus 1 \oplus \mathcal{G}(^>D_{n-i-1}^<),$$

so

$$c(n) = \text{mex} \left( \{ c(i-3) \oplus c(n-i-1) : 1 \leq i \leq \lceil (n+1)/2 \rceil \} \cup \{ c(i-2) \oplus 1 \oplus c(n-i-1) : 0 \leq i \leq \lfloor (n+1)/2 \rfloor \} \right) \quad (5)$$

for all  $n \in \mathbb{N}$ . Now, we are ready to prove that  $(c(n) : n \geq 69)$  is periodic with period 12 by strong induction.

With recursion (5), together with the initial conditions  $(c(-2), c(-1), c(0)) = (0, 0, 2)$ , we can compute the values of the sequence  $(c(n) : 1 \leq n \leq 175)$ , which is periodic with period 12 when  $69 \leq n \leq 175$ . Assume that for some  $n \geq 176$ ,  $c(i) = c(i-12)$  for all  $81 \leq i < n$ .

Then

$$\begin{aligned}
c(n) &= \text{mex} \left( \{c(i-3) \oplus c(n-i-1) : 1 \leq i \leq \lceil (n+1)/2 \rceil - 6\} \right. \\
&\quad \cup \{c(i-3) \oplus c(n-i-1) : \lceil (n+1)/2 \rceil - 5 \leq i \leq \lceil (n+1)/2 \rceil\} \\
&\quad \cup \{c(i-2) \oplus 1 \oplus c(n-i-1) : 0 \leq i \leq \lfloor (n+1)/2 \rfloor - 6\} \\
&\quad \left. \cup \{c(i-2) \oplus 1 \oplus c(n-i-1) : \lfloor (n+1)/2 \rfloor - 5 \leq i \leq \lfloor (n+1)/2 \rfloor\} \right) \\
&= \text{mex} \left( \{c(i-3) \oplus c((n-12)-i-1) : 1 \leq i \leq \lceil ((n-12)+1)/2 \rceil\} \right. \\
&\quad \cup \{c(i-3) \oplus c((n-12)-i-1) : \lceil (n+1)/2 \rceil - 5 \leq i \leq \lceil (n+1)/2 \rceil\} \\
&\quad \cup \{c(i-2) \oplus 1 \oplus c((n-12)-i-1) : 0 \leq i \leq \lfloor ((n-12)+1)/2 \rfloor\} \\
&\quad \left. \cup \{c(i-2) \oplus 1 \oplus c((n-12)-i-1) : \lfloor (n+1)/2 \rfloor - 5 \leq i \leq \lfloor (n+1)/2 \rfloor\} \right) \\
&= \text{mex} \left( \{c(i-3) \oplus c((n-12)-i-1) : 1 \leq i \leq \lceil ((n-12)+1)/2 \rceil\} \right. \\
&\quad \cup \{c(i-3) \oplus c((n-12)-i-1) : \lceil (n+1)/2 \rceil - 17 \leq i \leq \lceil (n+1)/2 \rceil - 12\} \\
&\quad \cup \{c(i-2) \oplus 1 \oplus c((n-12)-i-1) : 0 \leq i \leq \lfloor ((n-12)+1)/2 \rfloor\} \\
&\quad \left. \cup \{c(i-2) \oplus 1 \oplus c((n-12)-i-1) : \lfloor (n+1)/2 \rfloor - 17 \leq i \leq \lfloor (n+1)/2 \rfloor - 12\} \right) \\
&= \text{mex} \left( \{c(i-3) \oplus c((n-12)-i-1) : 1 \leq i \leq \lceil ((n-12)+1)/2 \rceil\} \right. \\
&\quad \left. \cup \{c(i-2) \oplus 1 \oplus c((n-12)-i-1) : 0 \leq i \leq \lfloor ((n-12)+1)/2 \rfloor\} \right) \\
&= c(n-12),
\end{aligned}$$

which completes our induction.

Next, we study  $b(n)$ . By the symmetry of  $D_n^<$ , we have

$$b(n) = \text{mex}\{\mathcal{G}((D_n^<)_{v_{i,0}}), \mathcal{G}((D_n^<)_{v_{i,1}}) : 1 \leq i \leq n+1\}.$$

It is easy to see that

$$\mathcal{G}((D_n^<)_{v_{i,0}}) = \mathcal{G}(D_{i-3}^<) \oplus \mathcal{G}(^>D_{n-i-1}^<)$$

and

$$\mathcal{G}((D_n^<)_{v_{i,1}}) = \mathcal{G}(D_{i-2}^<) \oplus 1 \oplus \mathcal{G}(^>D_{n-i-1}^<),$$

so

$$b(n) = \text{mex}\{b(i-3) \oplus c(n-i-1), b(i-2) \oplus 1 \oplus c(n-i-1) : 1 \leq i \leq n+1\} \quad (6)$$

for all  $n \in \mathbb{N}$ . Now, we are ready to prove that  $(b(n) : n \geq 69)$  is periodic with period 12 by strong induction.

With recursion (6), together with the initial conditions  $(b(-2), b(-1), b(0)) = (0, 0, 2)$  and the sequence  $(c(n) : n \in \mathbb{N})$ , we can compute the values of the sequence  $(b(n) : 1 \leq n \leq 164)$ , which is periodic with period 12 when  $69 \leq n \leq 164$ . Assume that for some  $n \geq 165$ ,

$b(i) = b(i - 12)$  for all  $81 \leq i < n$ . Then

$$\begin{aligned}
b(n) &= \text{mex} \left( \{b(i - 3) \oplus c(n - i - 1), b(i - 2) \oplus 1 \oplus c(n - i - 1) : 1 \leq i \leq n - 82\} \right. \\
&\quad \left. \cup \{b(i - 3) \oplus c(n - i - 1), b(i - 2) \oplus 1 \oplus c(n - i - 1) : n - 81 \leq i \leq n + 1\} \right) \\
&= \text{mex} \left( \{b(i - 3) \oplus c((n - 12) - i - 1), b(i - 2) \oplus 1 \oplus c((n - 12) - i - 1) : \right. \\
&\quad \left. 1 \leq i \leq n - 82\} \right. \\
&\quad \left. \cup \{b(i - 3) \oplus c((n - 12) - i - 1), b(i - 2) \oplus 1 \oplus c((n - 12) - i - 1) : \right. \\
&\quad \left. n - 93 \leq i \leq n - 11\} \right) \\
&= \text{mex} \{b(i - 3) \oplus c((n - 12) - i - 1), b(i - 2) \oplus 1 \oplus c((n - 12) - i - 1) : \\
&\quad 1 \leq i \leq (n - 12) + 1\} \\
&= b(n - 12),
\end{aligned}$$

which completes our induction.

Finally, we study  $a(n)$ . By the symmetry of  $D_n$ , we have

$$a(n) = \text{mex} \left( \{\mathcal{G}((D_n)_{v_{i,0}}) : 1 \leq i \leq \lceil (n + 1)/2 \rceil\} \cup \{\mathcal{G}((D_n)_{v_{i,1}}) : 1 \leq i \leq \lfloor (n + 1)/2 \rfloor\} \right).$$

It is easy to see that

$$\mathcal{G}((D_n)_{v_{i,0}}) = \mathcal{G}(D_{i-3}^<) \oplus \mathcal{G}(D_{n-i-1}^<)$$

and

$$\mathcal{G}((D_n)_{v_{i,1}}) = \mathcal{G}(D_{i-2}^<) \oplus 1 \oplus \mathcal{G}(D_{n-i-1}^<),$$

so

$$\begin{aligned}
a(n) &= \text{mex} \left( \{b(i - 3) \oplus b(n - i - 1) : 1 \leq i \leq \lceil (n + 1)/2 \rceil\} \right. \\
&\quad \left. \cup \{b(i - 2) \oplus 1 \oplus b(n - i - 1) : 1 \leq i \leq \lfloor (n + 1)/2 \rfloor\} \right) \tag{7}
\end{aligned}$$

for all  $n \in \mathbb{N}$ . Now, we are ready to prove that  $(a(n) : a \geq 69)$  is periodic with period 12 by strong induction.

With recursion (7), together with the sequence  $(b(n) : n \in \mathbb{N})$ , we can compute the values of the sequence  $(a(n) : 1 \leq n \leq 175)$ , which is periodic with period 12 when  $69 \leq n \leq 175$ .



Assume that for some  $n \geq 176$ ,  $a(i) = a(i - 12)$  for all  $81 \leq i < n$ . Then

$$\begin{aligned}
a(n) &= \text{mex} \left( \{b(i - 3) \oplus b(n - i - 1) : 1 \leq i \leq \lceil (n + 1)/2 \rceil - 6\} \right. \\
&\quad \cup \{b(i - 3) \oplus b(n - i - 1) : \lceil (n + 1)/2 \rceil - 5 \leq i \leq \lceil (n + 1)/2 \rceil\} \\
&\quad \cup \{b(i - 2) \oplus 1 \oplus b(n - i - 1) : 1 \leq i \leq \lfloor (n + 1)/2 \rfloor - 6\} \\
&\quad \left. \cup \{b(i - 2) \oplus 1 \oplus b(n - i - 1) : \lfloor (n + 1)/2 \rfloor - 5 \leq i \leq \lfloor (n + 1)/2 \rfloor\} \right) \\
&= \text{mex} \left( \{b(i - 3) \oplus b((n - 12) - i - 1) : 1 \leq i \leq \lceil ((n - 12) + 1)/2 \rceil\} \right. \\
&\quad \cup \{b(i - 3) \oplus b((n - 12) - i - 1) : \lceil (n + 1)/2 \rceil - 5 \leq i \leq \lceil (n + 1)/2 \rceil\} \\
&\quad \cup \{b(i - 2) \oplus 1 \oplus b((n - 12) - i - 1) : 1 \leq i \leq \lfloor ((n - 12) + 1)/2 \rfloor\} \\
&\quad \left. \cup \{b(i - 2) \oplus 1 \oplus b((n - 12) - i - 1) : \lfloor (n + 1)/2 \rfloor - 5 \leq i \leq \lfloor (n + 1)/2 \rfloor\} \right) \\
&= \text{mex} \left( \{b(i - 3) \oplus b((n - 12) - i - 1) : 1 \leq i \leq \lceil ((n - 12) + 1)/2 \rceil\} \right. \\
&\quad \cup \{b(i - 3) \oplus b((n - 12) - i - 1) : \lceil (n + 1)/2 \rceil - 17 \leq i \leq \lceil (n + 1)/2 \rceil - 12\} \\
&\quad \cup \{b(i - 2) \oplus 1 \oplus b((n - 12) - i - 1) : 1 \leq i \leq \lfloor ((n - 12) + 1)/2 \rfloor\} \\
&\quad \left. \cup \{b(i - 2) \oplus 1 \oplus b((n - 12) - i - 1) : \lfloor (n + 1)/2 \rfloor - 17 \leq i \leq \lfloor (n + 1)/2 \rfloor - 12\} \right) \\
&= \text{mex} \left( \{b(i - 3) \oplus b((n - 12) - i - 1) : 1 \leq i \leq \lceil ((n - 12) + 1)/2 \rceil\} \right. \\
&\quad \left. \cup \{b(i - 2) \oplus 1 \oplus b((n - 12) - i - 1) : 1 \leq i \leq \lfloor ((n - 12) + 1)/2 \rfloor\} \right) \\
&= a(n - 12),
\end{aligned}$$

which completes our induction.  $\square$

By computation, we further discover that the sequences  $(a(n) : n \geq 4)$ ,  $(b(n) : n \geq 4)$ ,  $(c(n) : n \geq 4)$  are identical, and their repeating unit  $(a(n) : 69 \leq n \leq 80)$  is given by

$$7, 5, 0, 2, 8, 1, 4, 6, 3, 1, 8, 2.$$

In particular, the maximum Nimber value is 8, occurring at  $a(25)$ ,  $a(31)$ ,  $a(43)$ ,  $a(49)$ , and  $a(61 + 6k)$  for all nonnegative integers  $k$ . Also,  $a(n) = 0$  if and only if  $n = 3$  or

$$n \equiv 11 \pmod{12}.$$

It is worth mentioning that the Nimber sequence  $(c(n) : n \geq -1)$  is precisely the Nimber sequence for the ‘‘Remove-a-Square game’’ on an  $n \times 2$  rectangle, listed on the OEIS as [A286332](#) [7]. The Remove-a-Square game on an  $n \times 2$  rectangle is also an impartial game, where two players alternate to remove a  $1 \times 1$  or a  $2 \times 2$  square from the  $n \times 2$  rectangle. If we label the  $1 \times 1$  squares by  $s_{i,j}$  for  $0 \leq i \leq n - 1$  and  $j \in \{1, 3\}$ , then we can easily see that removing the  $1 \times 1$  square  $s_{i,j}$  is equivalent to removing  $N_{(>D_{n-2}^<)}[v_{i,j}]$ , and removing the  $2 \times 2$  square composed of  $s_{i,1}, s_{i,3}, s_{i+1,1}, s_{i+1,3}$  is equivalent to removing  $N_{(>D_{n-2}^<)}[v_{i+1,0}]$ . Therefore, the Remove-a-Square game on an  $n \times 2$  rectangle is equivalent to the Node-Kayles game on  $>D_{n-2}^<$ , thus the Nimber sequence  $(c(n) : n \geq -1)$  is the same as the Nimber sequence for the Remove-a-Square game on an  $n \times 2$  rectangle.

## 6 Nimbers of the Node-Kayles game on other graphs and concluding remarks

In the previous sections, we studied the Nimbers of the Node-Kayles game on 3-paths, lattice graphs, prism graphs, chained cliques, linked cliques, linked cycles, and linked diamonds. There are many other interesting families of graphs for us to examine. Two such families are hypercubes and generalized Petersen graphs. An  $n$ -dimensional hypercube, denoted by  $Q_n$ , is a graph with the vertex set  $\{0, 1\}^n$ , and between any two vertices  $(x_1, x_2, \dots, x_n)$  and  $(y_1, y_2, \dots, y_n)$  in  $\{0, 1\}^n$ , there is an edge if and only if  $\sum_{i=1}^n |x_i - y_i| = 1$ .

**Theorem 11.** *The Nimber  $\mathcal{G}(Q_n)$  is 1 if  $n = 1$  and is 0 otherwise.*

*Proof.* When  $n = 1$ ,  $Q_1$  is isomorphic to the path  $P_2$ , so  $\mathcal{G}(Q_1) = 1$ . When  $n > 1$ , let  $\varphi$  be a graph homomorphism on  $Q_n$  such that  $\varphi(x_1, x_2, \dots, x_n) = (1 - x_1, 1 - x_2, \dots, 1 - x_n)$ . Essentially,  $\varphi$  reflects the hypercube about the center of the hypercube. It is easy to check that  $\varphi$  is an involution that satisfies the condition in Theorem 4, so  $\mathcal{G}(Q_n) = 0$ .  $\square$

For each integer  $n \geq 5$ , a *generalized Petersen graph*, denoted by  $GP(n, 2)$ , is a graph with the vertex set  $\{u_0, u_1, \dots, u_{n-1}, v_0, v_1, \dots, v_{n-1}\}$  and the edge set  $\{u_i u_{i+1}, u_i v_i, v_i v_{i+2} : 1 \leq i \leq n\}$ , where addition in the indices is performed modulo  $n$ . The first twenty terms in the Nimber sequence  $(\mathcal{G}(GP(n, 2)) : n \geq 5)$  are calculated and now listed on the OEIS as [A316533](#) [7]. In general, we can determine the Nimber  $\mathcal{G}(GP(n, 2))$  when  $n$  is even, due to the following theorem.

**Theorem 12.** *The Nimber  $\mathcal{G}(GP(n, 2))$  is 0 if  $n$  is even.*

*Proof.* Let  $n = 2k$  for some integer  $k \geq 3$ . For any vertex  $w \in V(GP(n, 2))$ , let  $\varphi$  be a graph homomorphism on  $GP(n, 2)$  such that

$$\varphi(w) = \begin{cases} v_{i+n/2}, & \text{if } w = v_i; \\ u_{i+n/2}, & \text{if } w = u_i, \end{cases}$$

where addition in the indices is performed modulo  $n$ . Essentially,  $\varphi$  rotates the generalized Petersen graph by  $180^\circ$ . It is easy to check that  $\varphi$  is an involution that satisfies the condition in Theorem 4, so  $\mathcal{G}(GP(2k, 2)) = 0$ .  $\square$

We are unable to determine any explicit formula or recursion for the odd terms of this sequence at the moment, and this is one of our future goals. Additional goals include expanding the results of Sections 3 and 5. For example, our technique of studying the recursion will work for determining the Nimber sequence of  $(3, n)$ -linked 6-cycle, but it will not work for other linked cycles, such as  $(1, n)$ -linked 5-cycle, since removing a vertex no longer necessarily disconnects a component. It is in our interest to discover other techniques for determining the Nimber sequence of  $(1, n)$ -linked 5-cycle and other graphs that we fail to handle at the moment, such as the  $n \times 3$  lattice graph or all lattice graphs in general.

Furthermore, as mentioned in Section 5, the Nimber sequence of  $(1, n)$ -linked 4-cycle does not seem to be periodic. Another seemingly nonperiodic Nimber sequence is for the Node-Kayles game on the square of paths, namely  $(\mathcal{G}((P_n)^2) : n \in \mathbb{N})$ . However, there is an important open conjecture by Richard Guy that the Nimber sequences of all octal games are periodic. As we have shown in this paper, there are many connections between Node-Kayles games and octal games, so we would like to prove or disprove the periodicity of these Nimber sequences.

## References

- [1] H. L. Bodlaender and D. Kratsch, Kayles and Nimbers, *J. Algorithms* **43** (2002), 106–119.
- [2] E. R. Berlekamp, J. H. Conway, and R. K. Guy, *Winning Ways for Your Mathematical Plays, Vol. 1*, A. K. Peters, 2001.
- [3] E. Duchêne, S. Gravier, and M. Mhalla, Combinatorial graph games, *Ars. Combin.* **90** (2009), 33–44.
- [4] H. E. Dudeney, *The Canterbury Puzzles*, London, 1910.
- [5] A. Guignard and É. Sopena, Compound Node-Kayles on paths, *Theoret. Comput. Sci.* **410** (2009), 2033–2044.
- [6] S. Loyd, *Cyclopedia of Tricks and Puzzles*, New York, 1914.
- [7] N. J. A. Sloane et al., *The On-Line Encyclopedia of Integer Sequences*, 2020. Available at <https://oeis.org>.

---

2010 *Mathematics Subject Classification*: Primary 91A46; Secondary 91A43, 05C57, 11Y55.  
*Keywords*: Node-Kayles, Domination game, Sprague-Grundy, Nimber sequence, octal game, graph involution, periodic.

---

(Concerned with sequences [A002186](#), [A002187](#), [A071426](#), [A071441](#), [A071461](#), [A286332](#), [A316533](#), [A316629](#), [A316632](#), [A316781](#), and [A317367](#).)

---

Received November 10 2019; revised version received March 11 2020. Published in *Journal of Integer Sequences*, March 16 2020.

---

Return to [Journal of Integer Sequences home page](#).